

印刷条码
物料号:

LED Backlight TV

USER MANUAL

Read the manual carefully and ensure you have fully understood its contents before operating this device for the first time.

ES-
NO.1

English

Contents

Declaration and Important Safety Precautions

Declaration	2
Disposal of Used Electrical & Electronic Equipment	3
Warning	3
Safeguards	4

1-Shortcuts Instructions

1.1 Turning your TV on or off	6
1.2 Selecting the Input Source	6
1.3 Selecting the aspect ratio	6
1.4 Audio function	7
1.5 EPG	8
1.6 PVR/Timeshift	9

2-Menu

2.1 How to use the Menu	11
2.2 Using the Picture Menu	11
2.3 Using the Sound Menu	12
2.4 Using the Screen Menu	13
2.5 Using the Option Menu	13
2.6 Using the Network Menu	16
2.7 Using the Channel Menu	18

3-Advanced Features

3.1 How to use the Smart	21
3.2 Digital Media Player (DMP)	21
3.2.1 Playable formats list	21
3.2.2 Playing Video Files	21
3.2.3 Playing Music Files	22
3.2.4 Browsing Pictures	22
3.3 Picasa	24
3.4 Browser	24
3.5 Social TV (Facebook/Twitter)	25
3.6 Anyview stream	25

4-Other Information

4.1 Troubleshooting	27
4.2 Playable Format List	28

Declaration

Any content and service accessed through this device, while only intended for individual non-commercial use, shall be the property of the applicable third party and subject to protection by regulations and laws on copyright, patent, trademark and other intellectual property rights. No part of such content and service may be modified, duplicated, published, uploaded, distributed, translated, marketed, or used to make and distribute products derived from it without the prior permission of the content owner or service provider.

You acknowledge and agree explicitly that you will solely bear the risk associated with the use of this device, and further you will solely bear any risk related to satisfactory quality, performance and accuracy for any content and service accessed through this device. To the maximum extent permitted by applicable law, this device and any third party's content and service is provided as it is without any guarantee, express or implied.

Manufacturer hereby declare explicitly that Manufacturer shall not be held liable for any guarantee and conditions, express or implied, related to this device and any content and service, including but not limited to warranty on marketability, satisfactory quality, fitness for a particular purpose, accuracy, quiet use and non-violation of any third party's rights; to the maximum extent permitted by applicable law, Manufacturer gives no guarantee on the accuracy, validity, timeliness, legitimacy and completeness of any content or service provided through this device, or the fitness of such device, content or service for your particular requirement, or the protection from interruption and error during operation of such device, content or service; to the maximum extent permitted by applicable law, in any case, including fault or neglect, Manufacturer shall not be held liable for legal actions or indemnity obligation arising from any consequence as a result of or related to any information loaded in this device or use of such device, content or service by you or any third party .

Any content and service provided as it is together with this device shall be the property of the applicable third party, therefore Manufacturer gives no declaration or warranty on modification, suspension, cancellation, termination or abortion thereof, and shall not be held liable for legal actions or indemnity obligation arising thereof.

Manufacturer reserves the rights to restrict the use or access of certain content or service. As the content and service are transmitted through third party's network and transmission facilities, Manufacturer undertakes no customer service thereof or the obligation for such customer service.

Important Safety Precautions



This symbol alerts user about the presence of a dangerous voltage not isolated inside the product which can be sufficiently powerful to constitute a risk of electrocution.



This symbol alerts user about the presence of important operating instructions and maintenance in the document enclosed in the package.



ATTENTION

RISK OF SHOCK
ELECTRIC



Do not open the back cover.

In no case the user is allowed to operate inside the TV set.

Only a qualified technician is entitled to operate.

Disposal of Used Electrical & Electronic Equipment



Packaging and electrical goods should be recycled appropriately, and not treated as household waste. Please dispose of this equipment at your applicable collection point for the recycling of electrical & electronic equipment waste. By ensuring the correct disposal of this product, you will help prevent potentially hazardous to the environment and to human health, which could otherwise be caused by unsuitable waste handling of this product. The recycling of materials will help conserve natural resources. Please do not therefore dispose of your old electrical and electronic equipment with your household waste. For more detailed information about recycling of this product, please contact your local city office, your household waste disposal service or the shop where you purchased the product.



Incorrect replacement of the battery may lead to the risk, including the replacement of another similar or the same type. Do not expose batteries to heat such as sun or fire or something like that.



The device should not be exposed to dripping and spraying and it cannot be placed under objects filled with liquids.



Main plug is used as the disconnect device, the disconnect device shall remain ready for operating.

Warning

If a television is not positioned in a sufficiently stable location, it can be potentially hazardous due to falling. Many injuries, particularly to children, can be avoided by taking simple precautions such as:

- Using cabinets or stands recommended by the manufacturer of the television.
- Only using furniture that can safely support the television.
- Ensuring the television is not overhanging the edge of the supporting furniture.
- Not placing the television on tall furniture (for example, cupboards or bookcases) without anchoring both the furniture and the television to a suitable support.
- Not standing the televisions on cloth or other materials placed between the television and supporting furniture.
- Educating children about the dangers of climbing on furniture to reach the television or its controls.

Important Safety Precautions

Please read the following safeguards for your TV and retain for future reference. Always follow all warnings and instructions marked on the television.

1. A note about safety and operating instructions

Read and follow all safety and operating instructions, and retain them safely for future reference.

2. Heed Warnings

Adhere to all warnings on the appliance and in the operating instructions.

3. Cleaning

Unplug the TV from the wall outlet before cleaning. Do not use liquid, abrasive, or aerosol cleaners. Cleaners can permanently damage the cabinet and screen. Use a lightly dampened cloth for cleaning.

4. Wall Bracket

Wall brackets are not supplied with this product. After market brackets may be available to purchase locally. Please refer to the specification page for dimensions.

5. Water and Moisture

Avoid dripping or splashing of liquids onto the product. Objects filled with liquids, such as vases, should not be placed on the product.

6. Setting

Do not place this TV on an unstable cart, stand or table. Placing the TV on an unstable base can cause the TV to fall, resulting in serious personal injuries as well as damage to the TV. Use only a cart, stand, bracket or table recommended by the manufacturer or salesperson.

7. Ventilation

Slots and openings in the cabinet are provided for ventilation, to ensure reliable operation of the TV and to protect it from overheating. Do not cover the ventilation openings in the cabinet and never place the set in a confined space such as built-in cabinet unless proper ventilation is provided. Leave a minimum 10cm gap all around the unit.

8. Power Source

This TV should be operated only from the type of power source indicated on the marking label. If you are not sure of the type of power supplied to your home, consult your appliance dealer or local power company.

9. Power-Cord Protection

Power- supply cords should be routed so that they are not likely to be walked on or pinched by items placed upon or against them, paying particular attention to cords at plug, wall outlets, and the point where they exit from the TV. MAIN plug is used as the disconnect device, the disconnect device shall remain readily operable.

10. Lightning

For added protection for this TV during a lightning storm, or when it is left unattended and unused for long periods of time, unplug it from the wall outlet and disconnect the antenna or cable system. This will prevent damage to the TV due to lightning or power-line surge.

11. Power Lines

An outside antenna system should not be located in the vicinity of overhead power lines or other electric light or power circuits, or where it can fall into such power lines or circuits. Where installing an outside antenna system, extreme care should be taken to keep from touching such power lines or circuits as contact with them might be fatal.

Important Safety Precautions

12. Overloading

Do not overload wall outlets and extension cords as this can result in a risk of fire or electric shock.

13. Object and Liquid Entry

Never push objects of any kind into this TV through openings as they may touch dangerous voltage points or short-out parts that could result in fire or electric shock. Never spill liquid of any kind on or into the TV.

14. Outdoor Antenna Grounding

If an outside antenna or cable system is connected to the TV, be sure the antenna or cable system is grounded so as to provide some protection against voltage surges and built-up static charges.

15. Servicing

Do not attempt to service this TV yourself as opening or removing covers may expose you to dangerous voltage or other hazards. Refer all servicing to qualified service personnel.

16. Damage Requiring Service

Unplug the TV from the wall outlet and refer servicing to qualified service personnel under the following conditions:

- (a) When the power - supply cord or plug is damaged.
- (b) If liquid has been spilled, or objects have fallen into the TV.
- (c) If the TV has been exposed to rain or water.
- (d) If the TV does not operate normally by following the operating instructions. Adjust only those controls that are covered by the operating instructions as an improper adjustment of other controls may result in damage and will often require extensive work by a qualified technician to restore the TV to its normal operation.
- (e) If the TV has been dropped or the cabinet has been damaged.
- (f) When the TV exhibits a distinct change in performance - this indicates a need for service.

17. Replacement Parts

When replacement parts are required, be sure the service technician has used replacement parts specified by the manufacturer or have the same characteristics as the original part. Unauthorized substitutions may result in fire, electric shock or other hazards.

18. Safety Check

Upon completion of any service or repair to the TV, ask the service technician to perform safety checks to determine that the TV is in safe operating condition.

19. Heat

The product should be situated away from heat sources such as radiators, heat registers, stoves, or other products (including amplifiers) that produce heat.

Shortcuts Instructions

You can use shortcuts on the remote control for fast operation. Refer to the “ Quick Setup Guide ” for more information.

1.1 Turning your TV on or off

To turn your TV on or off (standby mode):

1. Plug the AC power cord into a socket outlet of AC power supply.
2. Switch on the Power switch at the bottom of the TV to turn on/off your TV.
3. When the TV is powered on, press the **[POWER]** button on the remote control, it goes into standby mode. Press the **[POWER]** button again to turn on your TV.

NOTES

- When your TV is in standby mode, it is still consuming power. To completely disconnect power, please remove the mains plug from the mains socket or switch off the Power switch.
- If your TV does not receive an input signal for several minutes, it automatically goes into standby mode.

1.2 Selecting the Input Source

Select the Input Source depending on the video device you have connected to your TV.

To select the input source:

1. Turn on your TV, then press the **[SOURCE]** button on the remote, the list of Source appears.
2. Press the **[▲/▼]** buttons to select the input source.
3. Press the **[OK]** button to confirm your selection.

1.3 Selecting the aspect ratio

You can set various display modes which are shown as follows. Press the **[ZOOM]** button, you can achieve: **4:3 / 16:9 / Zoom 1 / Zoom 2 / Smart Zoom / Auto / 1:1**.

There are two kinds of input signal. One is 4:3, the other is 16:9. When you press the **[ZOOM]** button, he can get different picture in different format. The recommended format for original 4:3 is 4:3 option or Auto and the preferable format for original 16:9 signal is 16:9 option or Auto.

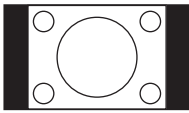
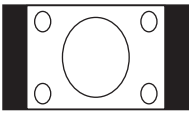
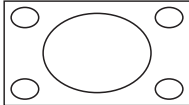
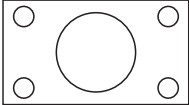
SIZE	Input Signal 4:3	Input Signal 16:9
4:3	This selection will allow you to view a picture with an original 4:3 aspect ratio. Black bars will appear on both the left and right of the screen. 	This selection will allow you to adjust the picture horizontally, in linear proportion. Black bars will appear on both the left and right of the screen. 
16:9	This selection will allow you to adjust the picture horizontally, in linear proportion, to fill the entire screen. 	This selection will allow you to view a picture with an original 16:9 aspect ratio. 

Shortcuts Instructions

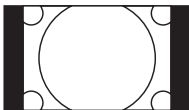
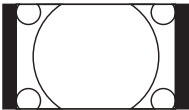
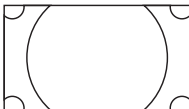
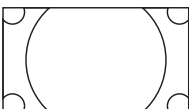
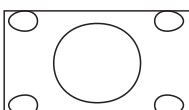
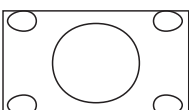
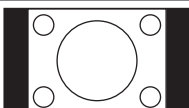
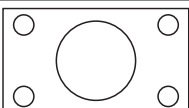
Zoom 1	This selection will allow you to zoom in the picture without any alteration. However, the top and bottom of the picture will be cropped. And it allow you to adjust the picture horizontally, in linear proportion. Black bars will appear on both the left and right of the screen.		This selection will allow you to zoom in the picture without any alteration. However, the top and bottom of the picture will be cropped. And it allow you to adjust the picture horizontally, in linear proportion. Black bars will appear on both the left and right of the screen.	
Zoom 2	This selection will allow you to zoom in the picture without any alteration, while filling the entire screen. However, the border of the picture will be cropped.		This selection will allow you to zoom in the picture without any alteration, while filling the entire screen. However, the border of the picture will be cropped.	
Smart Zoom	This selection is similar to 16:9 mode, but the picture slightly stretches horizontally side and clips off a little from the top and bottom.		This selection is similar to 16:9 mode, but the picture slightly stretches horizontally side and clips off a little from the top and bottom.	
Auto	This selection will display the picture according to the aspect ratio of the input source.		This selection will display the picture according to the aspect ratio of the input source.	
1:1	This selection will detect the resolution of the signal and display an image with the same number of pixels. The signal is optional in some source. (eg the HDMI source)			

1.4 Audio function (I/II)

Stereo/Dual Sound Reception (ATV Mode)

When a programme is selected, press the **[LANG./I/II]** button to display the sound information for the selected station.

Broadcast	On Screen Display
Mono	MONO
Stereo	NICAM STEREO
Dual	NICAM DUAL I, NICAM DUAL II, NICAM DUAL I+II

- **Mono sound selection:** If the stereo signal is weak in stereo reception, you can switch to mono by pressing the **[I/II]** button. In mono reception, the clarity of sound is improved. To switch back to stereo, press the **[I/II]** button again.
- **Language selection for dual language broadcast:** If a programme permits in two languages (dual language), you can switch to NICAM DUAL I, NICAM DUAL II, NICAM DUAL I+II or MONO by pressing the **[I/II]** button repeatedly.

NICAM DUAL I	Sends the primary broadcast language to the loudspeakers
NICAM DUAL II	Sends the secondary broadcast language to the loudspeakers
NICAM DUAL I+II	Sends the primary and secondary broadcast languages to the loudspeakers

Shortcuts Instructions

1.5 EPG

The EPG provides convenience to access to the television programmes that will be available in the next 7 days. The information displayed by the EPG is made available by the commercial television networks for digital channels only. It also provides a simple way to programme the recording of your favourite programmes and a reminder function which can automatically change channels at the correct time so that you do not miss programmes of interest. (The availability and amount of programme information will vary, depending on the particular broadcaster).

- Press the **[EPG]** button on the remote control to display channel information on programme guide list. You can press the **[▲/▼]** buttons to select the options.

RED (Recorder)		Press the [RED] button on the remote control while on the selected programme, the RECORDER menu will be displayed. Press the [▲/▼/◀/▶] buttons to select the settings in the RECORDER menu for the Channel/Start time/End time/ Mode . After finishing all the recorder adjustments, press the [OK] button to confirm your settings.
	Channel	Press the [◀/▶] buttons to select the channel that you want to record.
	Start time	Press the [▲/▼] buttons to select the Minutes/Hour/Month/Date and press the [◀/▶] buttons to adjust the start time.
	End time	Press the [▲/▼] buttons to select the Minutes/Hour/Month/Date and press the [◀/▶] buttons to adjust the end time.
	Mode	Press the [◀/▶] buttons to select the Once/Every Day/Weekly.
GREEN (Info)	Displays detailed information of the selected programme.	
YELLOW (Schedule)	Press the [YELLOW] button to view the preset reminders or scheduled recordings in the Schedule list.	
BLUE (Reminder)	Press the [BLUE] button while on the selected programme, the Reminder setting menu will be displayed.	

☒ NOTES

- Reminder is only available for programmes that haven't aired yet.
- An USB storage device must be attached to the television for recording purposes.
- Removing of the old file is not supported by the TV, you may need to connect the device to the computer to delete the unwanted files.
- The TV will record the programme even in standby mode.

1.6 PVR

PVR

The PVR enables the user to easily record the digital television content for later viewing. The function is to be used in DTV source only. The format of storage disk must be FAT32 or NTFS.

There are two options for recording, one option is to use Electronic Program Guide (EPG) and the other option is to press the **[PVR]** button.

Press the **[■]** button to stop record and a *.pvr file will be saved. The files can be played back in DMP or pressing **[Index]** button in remote.

Timeshift

Timeshift allows the user to watch a live broadcast (DTV only) with a delay. It can temporarily record the current programme onto a USB or portable storage device. Please connect a USB disk with a storage capacity of no less than 512M. Otherwise the recording will not be carried out.

Under live broadcast, press the **[||]** button on the remote control to pause the live broadcast. When you want to continue watching, press the **[▶]** button to resume watching from where you have stopped the programme. The PVR/Timeshift progress bar will be displayed on the screen or press **[■]** button to stop the Timeshift play.

The control bar operation (PVR/Timeshift)

Press **[RETURN]** button to enter the control bar while playing. Press the **[◀/▶]** buttons to select the icons and press **[OK]** button to confirm. And you can press the corresponding buttons on the remote control directly.

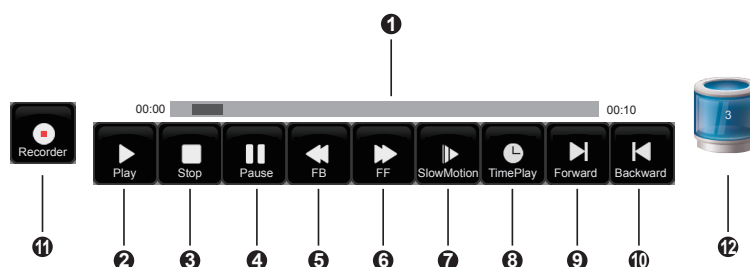

① The progress bar when playing.

② ③ ④ Play/Stop/Pause.

⑤ ⑥ Rewind /Fast Forward.

⑦ Slow Motion.

⑧ Time Play.

While playing, press the **[◀/▶]** buttons select the ⑧ Time Play button, then press the **[OK]** button to confirm. Set the time of the beginning to play, then press the **[OK]** button to confirm. The recorded program starts playing at the input time, it will exit when play completes automatically.

⑨ ⑩ Forward/Backward.

⑪ Recorder (Recorder button should not appear while playing recorded program) While recording, select the ④ Pause button to pause recording. If you need to continue recording, press the **[◀/▶]** buttons to select the ⑪ Recorder button, then press the **[OK]** button on the remote control to confirm, this program will continue recording.

Shortcuts Instructions

- ⑫ Occupancy of disk.

Timed looping

Enter the recorded program menu, press the [▲/▼] buttons to select recorded programs to play, press the [OK] button on the remote control to confirm. The program will all start playing from 00:00.

To use this function, selecting the part from A to B of the recorded program to circularly play, please operate as bellowing:

1. First, press the [◀/▶] buttons to select the ② Play button in the playback control bar, when play progress arrives at A point of the progress bar, pressing the [OK] button on the remote control to confirm, the progress bar will turn green.
2. Continue to play until to arrive at the B point, press the [OK] button again to select the ② Play button in the playback control bar, it will select the recorded part from point A to B of the progress bar ,and start looping play.
3. Press the [■] button, it will stop the loop and turn into the normal playback.

Recorded Program List: Allows to view the recorded programs

1. In DTV mode, press the [INDEX] button to enter the Recorder List.
2. Press the [▲/▼] buttons to select the Recorded Program List.
3. Press the [▶/OK] buttons to enter the submenu.
4. In the Recorded Program List, press the [◀/▶] buttons to change the page, press the [▲/▼] buttons to select the program and press the [OK] button to play.
5. You can press the [▲/▼] buttons to select the program and then press the [RED] button to delete it. The default order is accordance with the time and you can select the order type by pressing the [GREEN] button.

📌 NOTES

- Before you use the PVR and Timeshift function, you need to select the inserted device or disk where you want to store your PVR or Timeshift contents and then continue to operate according to the presentation of TV.

Please insert the FAT32 disk to the TV since TV is not able to format the disk.

Initiating Time shift for the first time, you can select between different allocated memory size (5min,10min and 20min) during this process all data will be erased. For PVR recording, the size of disk determines the maximum recording time.

- The PVR function is not supported for analogue channels
- The PVR functions are disabled for channels locked with Channel Lock or scrambled channels.
- For individual non-standard high-capacity mobile hard disk, if it's impulse current is greater than or equal 500mA, it may cause TV-rebooting or self-locking. So the TV does not support it.
- The USB port supports a voltage of 5V.
- The maximum supported storage space of the hard disk is 1T

2.1 How to use the Menu

1. Press the **[MENU]** button to open the main menu.
2. Press the **[▲/▼]** buttons to select a menu option, then press the **[▶/OK]** buttons to enter the menu.
3. In each menu, you can:
 - Press the **[▲/▼]** buttons to select an item,
 - Press the **[◀/▶]** buttons to adjust the value, or
 - Press the **[▶/OK]** buttons to enter the submenu,
 - Press the **[RETURN]** buttons to return to the previous menu.
4. Press the **[MENU/EXIT]** button to exit the menu.

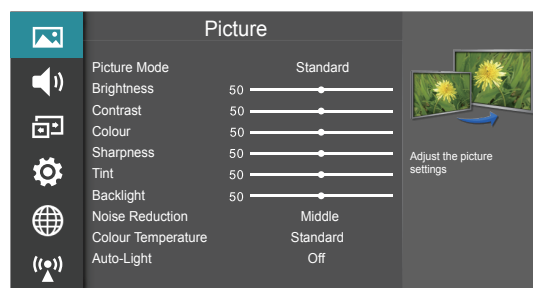

NOTE

- The menus in the user manual may vary slightly from the actual screen.

2.2 Using the Picture Menu

The picture setting allows the user to optimize the output quality picture of the TV.

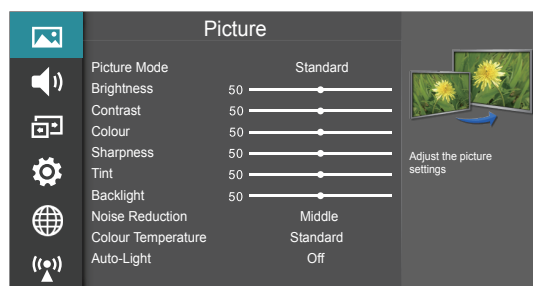

Picture Mode	For setting up the picture mode and improving the TV picture quality. Press the [MENU] button and then select Picture Mode. Based on the environment and the requirement select the correct picture mode from the following options: Standard, Soft, Bright, User, Dynamic.
Brightness	Adjust the overall luminance of the picture.
Contrast	Adjust the luminance ratio between black and white.
Colour	Adjust the colour saturation within the picture.
Sharpness	Adjust to achieve the optimum sharpness of edges and details within the picture.
Tint	Adjust flesh tones so that they appear natural. (Only available when receiving systems is NTSC)
Backlight	Change the backlight level.
Noise Reduction	Reduce the noise level of the connected devices. You could select one of the following options: Off, Low, Middle, High and Auto.

Menu

Colour Temperature	Adjust the colour components independently to achieve the desired warm or cool feeling by selecting one of the following options: Standard, Warm and Cool.
Auto-Light	Select Auto-light On or Off.

2.3 Using the Sound Menu

The sound setting allows the user to optimize the output audio sounds of the TV.

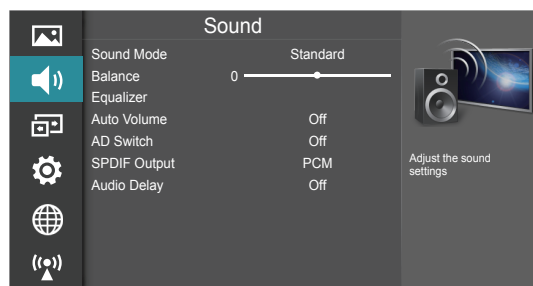

Sound Mode	Select the Sound Mode options based on the personal requirement: Standard / Music / Movie / Sport / User	
Balance	Adjust the relative volume of the speakers between the left and right speakers.	
Equalizer	Allow the users preset with the 5 band Equalizer controller. Press the [▶] button to select the different audio frequency band between 120 Hz, 500 Hz, 1.5 KHz, 5 KHz, and 10 KHz. Press the [▲/▼] buttons to adjust each of frequency band level individually.	
Auto Volume	This mode allows the users to automatically adjust the volume to reach a consistent level. This option is available by setting the Auto Volume Control to ON.	
AD Switch	<p>Audio Description is an auxiliary audio function that provides an additional audio track for visually challenged persons. This function handles the Audio Stream for the AD (Audio Description), when it is sent along with the main audio from the broadcaster.</p> <ul style="list-style-type: none"> · Set to “Off” for normal broadcasting sound coming out from speakers. · Set to “On” to activate the description sound track if available. The availability of Audio Description sound track is indicated by the visually impaired icon “V.I.” in the information banner. 	
SPDIF Output	PCM	PCM outputs two channel audio regardless of the input format.
	Auto	Select digital audio output format Auto.
Audio Delay	Allow very subtle adjustments between the syncing of sound and vision, you can select: 1, 2, ... , 10 or off.	

Menu

2.4 Using the Screen Menu

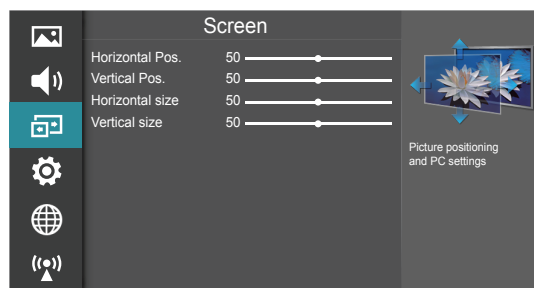

Horizontal Pos.	Adjusts the horizontal position of image.
Vertical Pos.	Adjusts the vertical position of image.
Horizontal size	Adjusts the horizontal size of image.
Vertical size	Adjusts the vertical size of image.

NOTE

- Depending on the input source or signal, the Screen Menu items will vary.

2.5 Using the Option Menu

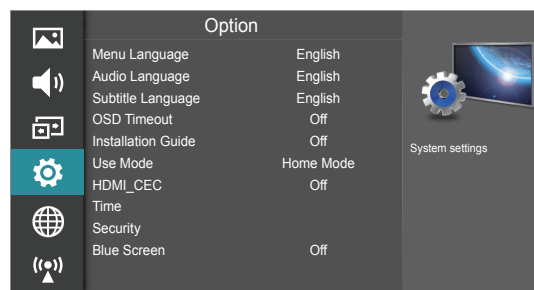

Menu Language	Select a preset Menu Language mode.
Audio Language	Allows you to select your desired audio language. Press the [◀/▶] buttons to select the Primary/ Secondary Audio Language. Press the [▼] button and then press the [▲/▼/◀/▶] buttons to select your desired audio language.
Subtitle Language	Allows you to select your desired subtitle language. Press the [◀/▶] buttons to select the Primary/ Secondary subtitle language. Press the [▼] button and then press the [▲/▼/◀/▶] buttons to select your desired subtitle language.
OSD Timeout	Allows you to select the display time of the on-screen menu: Off / 10S / 15S / ... / 60S.
Installation Guide	Press the [◀/▶] buttons to turn on or turn off the Installation Guide by selecting On or Off. If the Installation Guide is on, the menu as for the first installation will appear when you turn the TV on.

Menu

Use Mode	Select your Mode Setting: Home Mode or Shop Mode.	
	Home Mode	Recommended mode for the home use and low power consumption.
	Shop Mode	Optimizes the picture for store environments.
HDMI_CEC	Users can control HDMI CEC compatible device connected to the HDMI Jacks on TV according the remote control that came with TV. To use CEC function, you must set the HDMI_CEC on.	
	NOTES <ul style="list-style-type: none"> • HDMI Cables must be used to connect HDMI CEC compatible devices to your TV. • The connected device's HDMI CEC function must be tuned on. • If you connect One HDMI device that is not a HDMI CEC compatible,all the CEC Control function may not work. • Depending on the connected HDMI device,the CEC control function may not work. 	
	Device List	Display list of HDMI CEC devices that are connected to TV and select the source you want.
	HDMI_CEC	Turn CEC function on or off.
	Auto Standby	HDMI CEC device auto standby when you turn off TV.
	HDMI-ARC	When CEC is tuned on and you have connected an audio receiver to your TV ,turning on Audio Receiver lets you use your TV's remote control to control the volume on the audio receiver.
TIME	Auto Sync	Allows to adjust the date and time manual when it is set to Off. Select On to output the time information from digital signal (DTV).
	Clock	The clock is set automatically when receiving a digital signal.
	Off Time	Allows you to set the off time that the TV will switch off automatically.
	On Time	Allows you to set the on time that the TV will switch on automatically.
	Sleep Timer	<p>The sleep timer automatically switches the TV to standby after the preset time has elapsed. The clock will be set automatically when receiving a digital signal. Time must be set before using Sleep Timer function.</p> <p>Press the [◀/▶] buttons to select a period of time after which the TV automatically switches to standby mode: Off / 10 / 20 / ... / 180 / 240 Mins. The timer begins to count down from the number of minutes selected.</p> <p>NOTE</p> <ul style="list-style-type: none"> • If you turn the TV off after setting the sleep timer, the sleep timer setting will be erased.
	Auto Sleep	Select the Auto Sleep options based on the personal requirement: Off/3H /4H.

Menu

TIME	Time Zone	When you select a Time Zone city, the TV time is set by the time offset information based on Time Zone and GMT (Greenwich Mean Time) which is received with the broadcast signal and the time is set automatically by a digital signal.
Security	Prevent unauthorized users, such as children, from watching unsuitable programme. When you first use this function, the default password is [0000] . Once you input this password, you can continue to the next operation. You can change password in the Change PIN submenu.	
	Lock System	<p>The Lock System is designed to prevent accidental retuning of the TV / losing channels and prevent children watching unsuitable programmes.</p> <p>The Lock System must be set to On for this function to operate. If the Lock System is set to On, a valid password must be entered when you access Reception Type/Automatic Scan/Digital TV Manual Scan /Analogue TV Manual Scan/Edit Programmes/Export to USB/Import from USB/Restore Factory Default.</p> <p>NOTE</p> <ul style="list-style-type: none"> To access the Lock System menu, you must press the [◀/▶] buttons to select On and enter the password. Enter the default password "0000" for first time use.
	Change PIN	If you want to change the default PIN, you should enter the old PIN first and then enter the new one two times. The new PIN will be activated.
	Block Programme	This function can let you block some programs according to contents.
	Parental Guidance	<p>This function allows you to set up blocking schemes to block programmes and channels with age ratings. It operates according to information from the broadcasting station, therefore if the signal has incorrect or no information, this function will not operate.</p> <p>NOTE</p> <ul style="list-style-type: none"> When a programme is blocked, a valid PIN has to be entered when switching to these programmes.
	Child Lock	Press the [◀/▶] buttons to select On or Off. To prevent unauthorized users, such as children, from changing TV's settings.
Blue Screen	Allows the blue screen to turn On/Off during no signal conditions. (Only available in ATV mode)	
PVR File System(DTV Mode)	Select Disk	Select the disk where you want to store your recorded content.
	Timeshift Size	After formatting, press the [◀/▶] button to show the size of the memory.
	Format Start	Press the [OK] button to confirm and then the [◀] button to start formatting.
	Speed Check	This shows you the transfer rate of your USB storage device.

Menu

Software Update	Check your TV's software version and upgrade it if necessary.	
	USB Update	Update the software using a USB memory device.
Restore Factory Settings	Restore all settings to the factory defaults.	
Version	Display the software version information.	
Disclaimer	View the service statement. (May not be available, depending on your regions and country.)	

2.6 Using the Network Menu

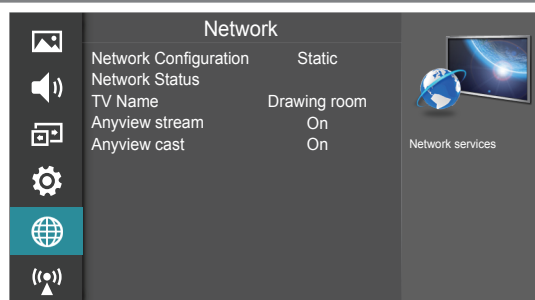

You can set the TV network by selecting Configuration and press the **[OK]** button to enter the submenu.

Network Configuration

Wired Network

1. On the Network Configuration screen, press the **[▲/▼]** buttons to select Wired Network and press the **[OK]** button to enter the submenu.
 2. On the Wired Network screen, press the **[▲/▼]** buttons to select Configuration and press the **[OK]** button to enter the submenu. See Figure 1.
 3. On the Network Configuration, you can press the **[◀/▶]** buttons to select DHCP (Auto) or Static (Manual). See Figure 2.
- **DHCP**(Dynamic Host Configuration Protocol): Acquire the necessary connection values and connect your TV to a network automatically.

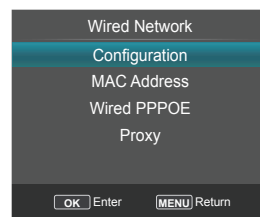

Figure 1

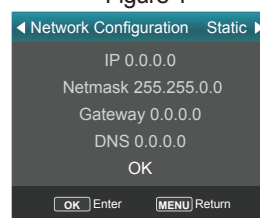

Figure 2

Menu

<p>Network Configuration</p>	<p>Wired Network</p>	<ul style="list-style-type: none"> · Static: Manually Input the connection values such as IP, Netmask, Gateway and DNS by using the [◀/▶] buttons or Numeric buttons. <p>When done, press the [OK] button to connect the network.</p> <p>NOTE</p> <ul style="list-style-type: none"> · Some networks require a Static IP address. To get the IP address, subnet mask, gateway and DNS values, check the settings of the router/modem or your PC or contact the network provider.
<p>Network Configuration</p>	<p>Wi-Fi Network</p>	<ol style="list-style-type: none"> 1. On the Network Configuration screen, press the [▲/▼] buttons to select Wi-Fi Network and press the [OK] button to enter the submenu. 2. On the Wi-Fi Network screen, press the [◀/▶] buttons to select On or Off. See Figure 1. If you select On, you can set up your TV's Wi-Fi Network connection. Select Base Station to enter the submenu. 3. If you have a wireless network around, all the existing wireless network will appear on the screen. When connecting to certain network, press the [▲/▼] buttons to select the wireless network you want to connect and press the [OK] button to confirm. The screen of Please Enter Password will pop up. After entering the password, press the [BLUE] button to connect. If there is no password, you can press the [BLUE] button to connect directly. 4. If the wireless network connect successful, the screen will appear the prompt "Success".
<p>Network Status</p>	<p>Display network connection status.</p>	
<p>TV Name</p>	<p>Press the [◀/▶] buttons to select TV Name. The assigned name will appear on the external devices connected to the TV via the network.</p>	
<p>Anyview stream</p>	<p>You can push media files of your mobile devices or computers to display on your TV.</p> <ul style="list-style-type: none"> · TV side: Press the [◀/▶] buttons to set Anyview stream to On. · Mobile Device Setup: Establish a link between the TV and a computer/other mobile device, and then push media files to play on the TV. <p>NOTE</p> <ul style="list-style-type: none"> · Anyview stream is only available with the device must support DLNA or Anyview stream and be connected to the same network as the TV. 	

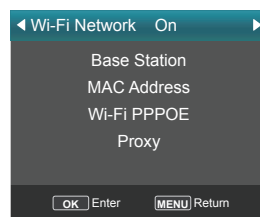

Figure 1

Menu

Anyview cast

Display mobile device screens on your TV wirelessly.

· TV side:

Press the [◀/▶] buttons to set Anyview cast to On.

· Mobile Device Setup:

Run Anyview cast or Miracast function on the mobile device (Refer to the user manual of your device for more details). The TV will connect with the mobile device, and user can view the connected mobile device's screen on the TV.

NOTES

- Anyview cast is only available with mobile devices that support Anyview cast or Miracast.
- Depending on the network condition, screen or voice dropouts may occur when the Anyview cast function is running.
- Due to compatibility issues, some Miracast models can not be supported on the TV.
- Anyview cast will be unavailable when you watch video via any application.

2.7 Using the Channel Menu

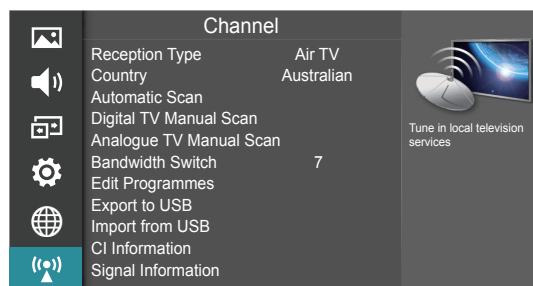

2.7.1 When the Reception Type is set to Air TV

Reception Type	Select a preset Reception Type: Air TV .	
Country	Select the Country you are in.	
Automatic Scan	Use this to automatically find and store all available channels. In the Channel search menu, you can select DTV+ATV Scan, DTV Scan or ATV Scan, and then press the [OK] button to search the channels.	
Digital TV Manual Scan	Allow you to make manual fine tuning adjustments of the channel under DTV mode. When the Digital TV Manual Scan screen will pop up, press the [◀/▶] buttons to select the desired UHF channel or VHF channel and then press the [OK] button to commence the search of that channel. When the signal has been tuned, signal strength will be displayed on the screen.	
Analogue TV Manual Scan	Allows you to make manual fine tuning adjustments if the channel reception is poor under ATV mode.	
	Store to	Press the [◀/▶] buttons to select the channel number which you desired.



Menu

Analogue TV Manual Scan	Colour System	Select the color system: Auto, PAL, PAL M, PAL N, NTSC, SECAM.
	System	Select the sound system: I, DK, L, M, BG (L only for SECAM).
Analogue TV Manual Scan	Current Channel	Displays the current channel number.
	Search	Press the [◀/▶] buttons to start the manual tuning.
	Fine-Tune	Press the [◀/▶] buttons to make manual fine tuning adjustments.
	Frequency	Display the current tuned frequency.

2.7.2 When the Reception Type is set to Cable

Reception Type	Select a preset Reception Type: Cable	
Country	Select the Country you are in.	
Automatic Scan	Use this to automatically find and store all available channels. In the Channel search menu, you can select DTV+ATV Scan, DTV Scan or ATV Scan, and then press the [OK] button to search the channels.	
Digital TV Manual Scan	Allows you to make manual fine tuning adjustments of the channel under DTV mode.	
	Frequency	When the Digital TV Manual Scan screen will pop up, press the [▲/▼] buttons to select Frequency and then the [◀/▶] button to select frequency or press the [0~9] buttons to input the frequency.
	Symbol	Press the [◀/▶] button to select the symbol or press the [0~9] buttons to set the symbol.
	Modulation	Press the [◀/▶] button to select modulation type.
	Search	Press the [▲/▼] buttons to select "Search" item, Press the [OK] button to start the search of that channel.
Analogue TV Manual Scan	Allows you to make manual fine tuning adjustments if the channel reception is poor under ATV mode.	
	Store to	Press the [◀/▶] buttons to select the channel number which you desired.
	Colour System	Select the color system: Auto, PAL, PAL M, PAL N, NTSC, SECAM.
	System	Select the sound system: I, DK, L, M, BG (L only for SECAM).
	Current Channel	Display the current channel number.
	Search	Press the [◀/▶] buttons to start the manual tuning.
	Fine-Tune	Press the [◀/▶] buttons to make manual fine tuning adjustments.
	Frequency	Display the current tuned frequency.

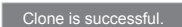
Menu

Bandwidth Switch	<p>Press the [◀/▶] buttons to select the bandwidth. (May not be available, depending on your regions and country.)</p>
Edit Programmes	<p>Edit the channels, including:</p> <ul style="list-style-type: none"> • Delete: Press the [RED] button to delete the selected channel. • Rename (Not available in DTV mode): Press the [GREEN] button to rename the selected channel. Press the [▲/▼] buttons to select the characters to represent the station name. Press the [◀/▶] buttons to move to the next character and then press the [GREEN] button again to confirm the new name. • Skip: Press the [BLUE] button to skip the selected channel when zapping. Press the [BLUE] button again to undo it. • Sort: Press the [◀/▶] buttons to sort the channel list, you can select None, 0-9 and a-z. • Page up/down: Press the [CH +/-] button to scroll the channel list. • FAV: Press the [FAV] button to set the selected channel as one of the favorite programmes. Press the [FAV] button again to undo it.
Export to USB	<p>Clone the channel list from TV to a USB device.</p> <ol style="list-style-type: none"> 1. Insert a USB storage device to the USB jack. 2. Select the Export To USB mode. A pop-up menu appears, press the [◀/▶] buttons to select whether to start copying the programme list. (Only DTV channels will be copied) 3. If the Figure 1 shows, it means that the importing was successful. (Figure 1)  (Figure 2)  <p>If the figure 2 shows the export was not successful, please check the following:</p> <ul style="list-style-type: none"> • Check if the USB storage is inserted and working properly. • This function is only available for DTV channels. • Clone function only works with same size and model.
Import from USB	<p>Clone the channel list from a USB device to TV.</p> <ol style="list-style-type: none"> 1. Insert the USB storage on which you saved the edited channel list to your TV. 2. Press the [▶] or [OK] button to select the Export To USB mode. A pop-up menu appears, press the [◀ / ▶] buttons to select whether to start copying the programme list. 3. If the importing was successful, the TV will Re-start. If the figure  shows, the import was not successful, please check the following: <ul style="list-style-type: none"> • Check if the USB storage is inserted and working properly. • This function is only available for DTV channels.
Signal Information	<p>Display detail signal informations. (DTV mode)</p>

3.1 How to use the Smart

1. Press the [HiSmart] button to display network main menu.
2. Press the [◀/▶] buttons to select each option.
3. Press the [OK] button to enter the option.
4. Press the [EXIT] button to exit the menu.

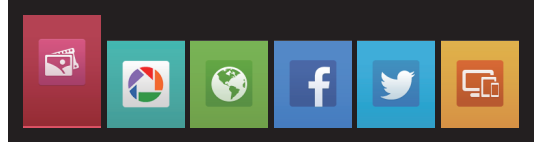

NOTE

- Be sure the network is in good condition.

3.2 Digital Media Player (DMP)

Be sure to insert the USB disk/mobile hard disk with standard USB2.0 port.

Press the [HiSmart] button to display the smart menu, press the [◀/▶] buttons to select the Media option, then press the [OK] button to confirm.

Or you can press the [DMP] button to enter the Media mode directly (If you want to exit DMP, you can press the [EXIT] button to exit DMP).

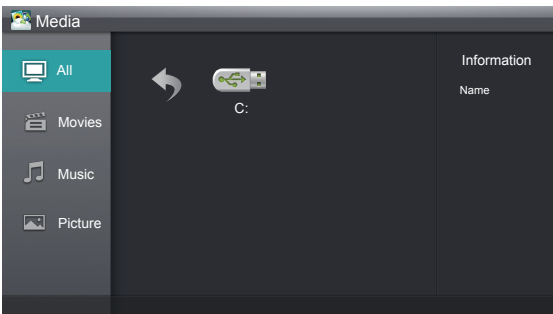

3.2.1 Playable formats list

This unit has USB digital multimedia player. It can identify such standard USB1.1 and USB2.0 devices as hardware, USB disk, etc.

You can browse the images, listen to music, and enjoy various files such as MPEG1, MPEG2, MPEG4, DAT, etc.

Signal Mode	Support Format
Picture	JPEG / BMP / PNG
Music	MP3 / LPCM
Video	MPEG1(.dat) / MPEG2(.mpg) / MPEG4(.mpg) / H.264

NOTES

- We cannot promise that this unit would support all the formats listed above, as the programming tools are different.
- Manufacturer does not assume any responsibility for any lost data and cannot guarantee perfect compatibility with all mass storage devices.

3.2.2 Playing Video Files

1. Press the [▲/▼] buttons to switch to All or Movies.
2. Press the [▶] button on the remote control to select the USB icon and then press the [OK] button to enter.
3. Press the [▲/▼/◀/▶] buttons to select the video you want to view.
4. Press the [OK] button to play the video.
5. Press the [■] / [EXIT] buttons to exit or return to the previous directory.
6. Press the [MENU] button to display/exit the picture control bar.
7. Press the [◀/▶] buttons to select the function icon and then press the [OK] button to confirm.

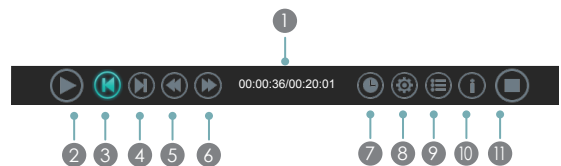

Function of icons:

- 1 The progress bar when playing.

Advanced Features

- 2 Play/Pause. You can press the [▶]/[II] button on the remote control directly to play/pause when there is no control bar on the screen.
- 3 Play the previous video. You can press the [◀◀] button directly to achieve the function when no control bar displayed on the screen.
- 4 Play the next video. You can press the [▶▶] button to achieve the function when no control bar displayed on the screen.
- 5 Fast rewind. Press the [OK] button to select the backward speed. You can press the [◀◀] button to achieve the function.
- 6 Fast forward. Press the [OK] button to select the forward speed. You can press the [▶▶] button to achieve the function.
- 7 Select time to play.
 - Press the [◀/▶] buttons to select the position you want to set.
 - Press the [0~9] buttons to set the time and press the [▲/▼/◀/▶] buttons to adjust it.
 - Press the [OK] button to confirm and the video will play at the time you have set.
- 8 Options.

Press the [▲/▼] buttons to select the options in the menu, press the [◀/▶] buttons to select the settings, and then Press the [OK] button to confirm.
- 9 Play list
 - Press the [▲/▼] buttons to select the video.
 - Press the [OK] button to confirm. And press the [EXIT] button to exit the menu.
- 10 Program info

It allows you to view the program information.
- 11 Stop playback

NOTE

- You can press the [ZOOM] button to change the aspect ratio (Fit, Full Screen, Original) while playing the video.

3.2.3 Playing Music Files

1. Press the [▲/▼] buttons to switch to All or Music.
2. Press the [▶] button on the remote control to select the USB icon and then press the [OK] button to enter.
3. Press the [▲/▼/◀/▶] buttons to select the music you want to listen.
4. Press the [OK] button to play the music.
5. All the music is listed on the left. Press the [▲/▼] buttons to select the music and press the [▶] button to mark it. You can press the [CH ▲] / [CH ▼] buttons to turn to the previous / next page. Press the [GREEN] button to select the Repeat Mode: All / Mark / One.
6. Press the [EXIT] button to exit the music playback interface.

3.2.4 Browsing Pictures

1. Press the [▲/▼] buttons to switch to All or Picture.
2. Press [▶] button on the remote control to select the USB icon and then press the [OK] button to enter.
3. Press the [▲/▼/◀/▶] buttons to select the picture you want to view.
4. Press the [OK] button to display picture.
5. Press the [■] / [EXIT] buttons to exit or return to the previous directory.

When browsing the pictures.

- Press the [MENU] button to display/exit the picture control bar.
- Press the [◀/▶] buttons to select the function icon and then press the [OK] button to confirm.



- 1 Browse the previous picture. You can also press the [◀◀] button on the remote control directly when no control bar displays on the screen.
- 2 Browse the next picture. Press the [▶▶] button directly on the remote control when no control bar displays on the screen.

Advanced Features

③ ④ Rotate

Rotate the picture 90 degrees clockwise.

Rotate the picture 90 degrees anti-clockwise.

⑤ Play/pause. Press the [▶]/[II] button directly when no control bar displays on the screen.

⑥ Stop browsing the picture. You can press the [■] button directly when no control bar on the screen.

⑦ Zoom in the picture.

⑧ Zoom out the picture.

⑨ Option Set.

Press the [▲/▼] buttons to select the options and press the [◀/▶] buttons to set them.

- Show Speed - Allows you to browse the picture at different speed.
- Show Style - Allows you to set how the picture appears on the screen.
- Background Music - Allows you to enjoy the music when browsing the pictures if it is set On.

⑩ Picture info. Displays information about the pictures.

⑪ If the background Music is on (You need to put the audio files and picture in a folder):

Press the [RED] button to play the previous music in the current directory.

Press the [GREEN] button to play the next music in the current directory.

- Do not pull out the USB devices during reading the files, or this may damage your system files.
- As the system is constantly updated, there may be some difference between the on-screen-menu and this instruction without notice.
- When user uses USB devices, we recommend that the total partition number of all devices does not exceed 11, otherwise the information on partition may not be displayed.
- When the system can not work for a long time or there is a prompt for the abnormal system, the current system may be in a abnormal operation condition. You'd better retry the current operation or restart the TV.
- If the hard disk can't be identified, Try to supply the disk with external power or replace with the standard USB2.0 cable shorter than 65 centimeters.

📌 NOTES

- Never remove the USB flash drive or turn off your TV while a file is opened.
- Most USB storage devices are supported by the TV, non the less compatability problems might occur. Please check if the storage complies with the TV USB requirements.
- The USB port supports the voltage of 5V and the maximum current of 500mA. Some storage devices are different from standard USB protocols, so it will affect the correct identification, please make sure the USB storage you are using is compliant.
- The time the TV needs to read data from the storage depends on the speed of the USB storage and its capacity.

3.3 Picasa

□ Brief introduction

The Picasa App allows you to explore featured photos in Google Picasa Web Album, as well as search for your favorite photos. If you already have a Google Picasa account, you can enjoy the private photos you already have stored in your Google Picasa Web Album.

□ Operation instructions

1. Press the **[HiSmart]** button to display network main menu.
2. Press the **[◀/▶]** buttons to select the Picasa icon and press the **[OK]** button. The Picasa main interface screen will appear.



1. Picture Display Area
 2. You can press the **[1]** button on the remote control to select the Explore to browse all the pictures which other people share on the Picasa.
 - Press the **[2]** button on the remote control to enter My Photos and display the photo album which you login.
 - Press the **[3]** button on the remote control to display friends' accounts list in the logged account.
 3. The functional keys on the remote control e.g. Press the **[RED]** button on the remote control, the Login interface will pop up.
3. Press the **[Return]** button to return to the upper menu, or the **[Exit]** button to close the App.

3.4 Browser

□ Brief introduction

The browser allows you to browse any URL, add bookmarks and select websites from the bookmarks.

□ Operation instructions

1. Press the **[HiSmart]** button to display the network main menu.
2. Press the **[◀/▶]** buttons to select the Browser icon and press the **[OK]** button to enter it.
3. When the Browser screen pop up, press the **[▲/▼/◀/▶]** buttons to select the website you want, press the **[OK]** button to enter the website.

● Tool Bar

When the default interface will appear on the screen. There are some function icons on the top of the screen:

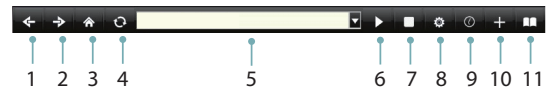

1. Back to previous page.
Move the cursor to the icon and press the **[OK]** button to return to the previous viewed web page.
2. Forward to next page.
Move the cursor to the icon and press the **[OK]** button to go forward to the previous viewed web pages.
3. Main page.
Move the cursor to the icon and press the **[OK]** button to show the main page.
4. Refresh page.
Move the cursor to the icon and press the **[OK]** button to refresh the current page.
5. Address bar.
Input the website you want to view.
6. Go to the website.
Move the cursor to the icon and press the **[OK]** button to search the website.
7. Stop loading the website.
Move the cursor to the icon and press the **[OK]** button to stop loading the website.

Advanced Features

8. Set up.
Open the system settings, settings for browsing data, etc.
9. View history website.
Move the cursor to the icon and press the [OK] button to view the website.
10. Add a bookmark.
Move the cursor to the icon and press the [OK] button to add the website to the favorite folder.
11. Bookmark manager.
Move the cursor to the icon and press the [OK] button to enter the favorite folder.

To use Twitter on smart TV:

Input account and password in the Twitter account login window. Then Move the cursor to "Login" key and press the [OK] button to Login. Once you have done this, your TV will be connected with Twitter and ready to use.

To use those features, press the corresponding numeric button on the remote control.



The functional keys on the remote control

3.5 Social TV (Facebook / Twitter)

Brief introduction

Smart TV has developed the "Social TV" feature, which allows the user to share whatever he or she finds online with their family and friends via Facebook and Twitter. The user must first create a registered account with these social media applications.

Operation instructions

1. Press the [HiSmart] button to display network main menu.
2. Press the [◀/▶] buttons to select the Facebook or Twitter icon and press the [OK] button to enter it.

To use Facebook on smart TV:

Input account and password in the Facebook account login window. Then Move the cursor to "Login" key and press the [OK] button to Login. Once you have done this, your TV will be connected with Facebook and ready to use.

To use those features, press the corresponding numeric button on the remote control.



The functional keys on the remote control

3. If you want to close the Apps, you can press the [Exit] button.

3.6 Anyview stream

Brief introduction

Anyview stream makes it easy to retrieve and enjoy media files from computers or mobile devices. However, the devices need to support Anyview stream or DMS and be connected to the same network as the TV.

Operation instructions

1. Press the [HiSmart] button to display network main menu.
2. Press the [◀/▶] buttons to select the Anyview stream icon and press the [OK] button to enter it.



Advanced Features

3. Select the media type (Movie, Music or Photo) at the bottom of the Anyview stream screen and then select the retrieved device where the media file is located at the top of the screen. The folder and file list of the selected device are shown.
4. If you want to close Anyview stream, you can press the **[Exit]** button.

Other Information

4.1 Troubleshooting

If the TV does not operate as usual or appears to be faulty please read carefully this section. Many operational issues can be resolved by users.

It is also advisable to unplug the TV from the AC socket on the wall for 60 seconds or more, then reconnect and start again. This simple procedure helps in restoring stable conditions for electric circuits and firmware of the unit.

Please contact Manufacturer Customer Care if the problem is unresolved or you have other concerns.

SYMPTOMS	POSSIBLE SOLUTIONS
No sound or picture.	<ul style="list-style-type: none">● Check if the power cord is plugged into a powered AC outlet.● A power switch on the right side bottom edge of the front panel must be turned on. Press the [POWER] button in the remote control to activate the unit from Standby.● Check to see if LED light is either red or blue. If illuminated, power to TV is OK.
I have connected an external source to my TV and I get no picture and/or sound.	<ul style="list-style-type: none">● Check for the correct output connection on the external source and for the correct input connection on the TV.● Make sure you have made the correct selection for the input mode for the incoming signal.
When I turn on my television, there is a few second delay before the picture appears. Is this normal?	Yes, this is normal. That is the TV searching for previous setting information and initializing the TV.
Picture is normal, but no sound.	<ul style="list-style-type: none">● Check the volume settings.● Check if Mute mode is set "on".
Sound but no picture or black and white picture.	<ul style="list-style-type: none">● If black and white picture first unplug TV from AC outlet and re-plug after 60 seconds.● Check that the Color is set to 50 or higher.● Try different TV channels.
Sound and picture distorted or appear wavy.	<ul style="list-style-type: none">● An electrical appliance may be affecting TV set. Turn off any appliances, if interference goes away, move appliance farther away from TV.● Insert the power plug of the TV set into another power outlet.
Sound and picture is blurry or cuts out momentarily.	<ul style="list-style-type: none">● If using an external antenna, check the direction, position and connection of the antenna.● Adjust the direction of your antenna or reset or fine tune the channel.
Horizontal/vertical stripe on picture or picture is shaking.	Check if there is interfering source nearby, such as appliance or electric tool.
The plastic cabinet makes a "clicking" type of sound.	"Click" sound can be caused when the temperature of the television changes. This change causes the television cabinet to expand or contract, which makes the sound. This is normal and the TV is OK..

Other Information

Remote control does not work.	<ul style="list-style-type: none"> ● Confirm that TV still has power and is operational. ● Change the batteries in the remote control. ● Check if the batteries are correctly installed.
Smart Television with wireless network capability Wi-Fi fail to join a local network.	<ul style="list-style-type: none"> ● Configure the local wireless router or access point for WPA-PSK security before attempting to connect the TV to the Wi-Fi network. ● Follow instruction in the User Manual of the television to setup a wireless connection

Playable Format List

File Extension	Container	Video Decoder	Resolution	Frame/Sec	Audio Decoder
*.avi	AVI	MPEG2 MP MPEG4 SP/ASP	1920x1080	30	MP3/AC3/MPEG4 AAC/MPEG2 AAC
		H.264 MP/HP	1920x1080	30	
*.asf	ASF	MPEG4 SP/ ASP	1920x1080	30	MP3
*.mp4	MP4	MPEG4 SP/ ASP	1920x1080	30	MP3/MPEG2 ACC/ MPEG4 AAC
		H.264 MP/HP	1920x1080	30	
*.mkv	MKV	H.264 MP/HP	1920x1080	30	MP3/MPEG2 AAC/ MPEG4 AAC/AC3
		MPEG4 SP/ ASP	1920x1080	30	
*.mpg *.mpeg	PS	MPEG1	768x576	30	MP3/AC3
		MPEG2 MP	1920x1080	30	
.ts	TS	H.264 MP/HP	1920x1080	30	MPEG Layer1/MPEG2 AAC/MPEG4 AAC
		MPEG2 MP	1920x1080	30	
*.FLV	FLV	H.264 MP/HP	1920x1080	30	MP3/MPEG2 AAC/ MPEG4 AAC
*.vob	PS	MPEG2 MP	1920x1080	30	MP3/AC3