

Hisense

49K3110PW
50K3110PW
55K3110PW

QUICK SETUP GUIDE

Before using the TV, please read this guide thoroughly and retain it for future reference. For more detailed instructions, please see the User Manual.

Contents



Incorrect replacement of the battery may lead to the risk, including the replacement of another similar or the same type. Do not expose batteries to heat such as sun or fire or something like that.



The device should not be exposed to dripping and spraying and it cannot be placed under objects filled with liquids.



Main plug is used as the disconnect device, the disconnect device shall remain ready for operating.

NOTES

- Excessive sound pressure from earphones and headphones can cause hearing loss.

Contents

Accessories List.....	1
Installing the Stand	2
TV Front.....	3
TV Rear	4
Making Connections.....	5
Remote Control	10
Turning the TV on for the First Time.....	12
Specifications	13

Accessories List

The following accessories are included with TV:



TV

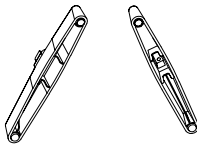

Base Stand



User Manual



Quick Setup Guide



AAA Batteries × 2



Remote Control



(ST4×16) × 4

Installing the Stand

Installing the Stand

⚠ CAUTION

- Be sure to disconnect the A/C power cord before installing a stand or Wall-Mount brackets.
- The LED display is very fragile, and must be protected at all times when installing the base stand. Be sure that no hard or sharp object, or anything that could scratch or damage the LED display, comes into contact with it. DO NOT exert pressure on the front of the TV at any time because the screen could crack.

Follow the illustrations and textual instructions below to complete the installation steps:

1. Carefully place your TV facedown on a soft, flat surface to prevent damage to the TV or scratching to the screen.
2. Remove the 2 stands from the accessory bag and then insert the stands into the bottom slots of the TV.
3. Secure the BASE STAND to the TV with the 4 screws in accessory tightly.

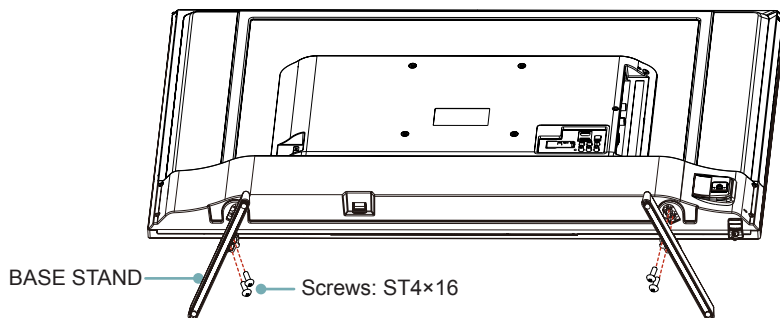

📌 NOTE

Pictures are only for reference, actual product may vary in appearance.

▶ WALL-MOUNT BRACKET (not provided)

<i>Wall-Mount hole pattern (mm)</i>	200 × 200
<i>Wall-Mount screw size (mm)</i>	M6

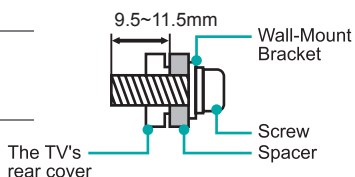

TV Front

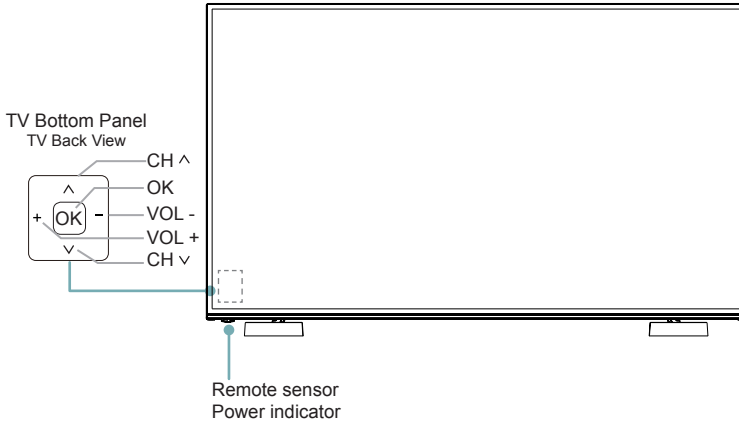

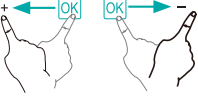
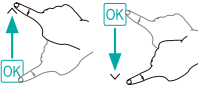
Item	Description
Remote sensor	Receive remote signals from the remote control. Do not put anything near the sensor, as its function may be affected.
Power indicator	The light is red in standby mode.
	Select among the different input signal sources and put the TV in standby mode, and you can turn on the TV when the TV in standby mode.
	Toggle the OK button left and right to adjust the volume.
	Toggle the OK button up and down to select the channel.

NOTES

- The Picture is Only for Reference.
- It takes several seconds to power on the TV and load program. Do not rapidly turn the TV on and off as it may cause the TV to work abnormally.

TV Rear

TV Rear

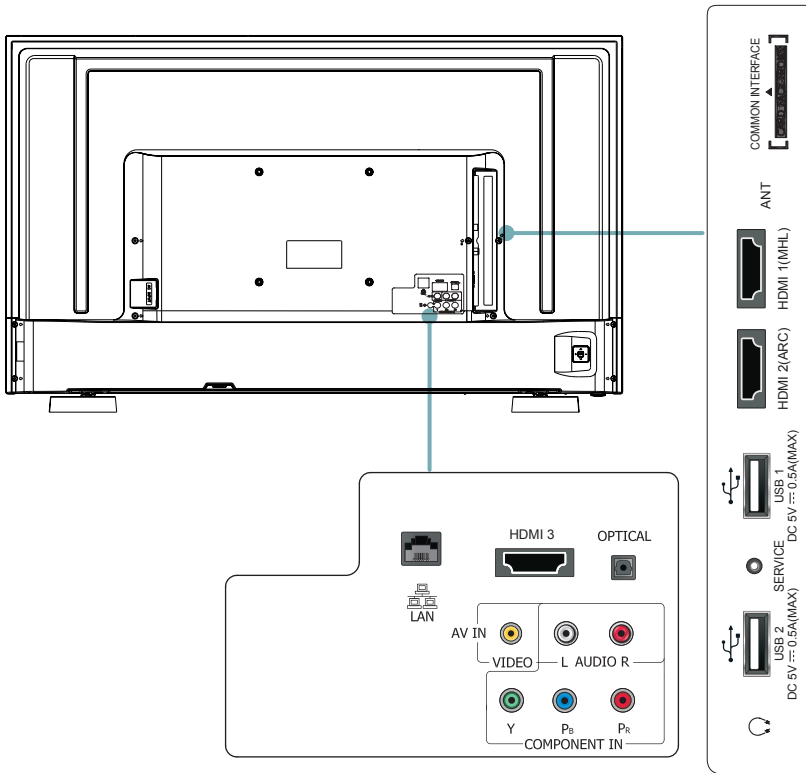

NOTES

- Check the jacks for position and type before making any connections. Loose connections can result in image or color problems. Make sure that all connections are tight and secure.
- The TV may not be compatible with all external devices. To check compatibility, please refer to the user manual of external device.
- Do not connect external equipment while TV's power cord is plugged in. It may cause electric shock.

Making Connections

- ▶ **ANT** Connect an outdoor VHF/UHF antenna or cable.

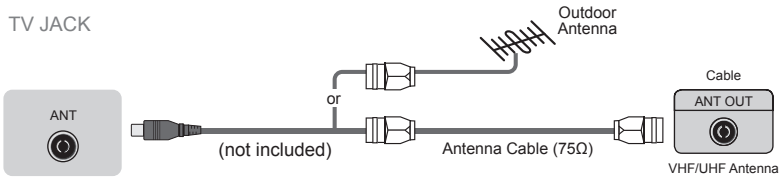

▶ **COMMON INTERFACE**

Insert the CI+ module for watching scrambled services like pay-tv channels or some HD channels.

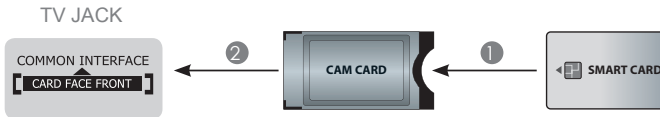

📖 **NOTES**

- Before you insert/remove the CI+ module, ensure that the TV is switched off. Then insert the CI card into the CI+ module in accordance with the Service Provider's instructions.
 - Do not repeatedly insert or remove the Common Access Module as this may damage the interface and cause a malfunction.
 - You must obtain a CI+ module and card from the service provider of the channels you want to watch.
 - Insert the CI+ module with the SmartCard in the direction marked on the module and SmartCard.
 - CI+ is not supported in some countries and regions; check with your authorized dealer.
- ▶ **HDMI/COMP/AV**
- Connect a HDMI / Comp / AV cable from an external AV equipment. No sound connection is needed for HDMI to HDMI connection. If the signal resolution does not match the specification table, you need to change the setting of device according to the table. Please consult your device user manual for instruction.
- To select the HDMI / Component / AV
Press [Input] button, when the list of input Source appears, press [**<** / **>**] to select the source [HDMI] / [COMPONENT] / [AV], then press [OK] to connect.

Making Connections

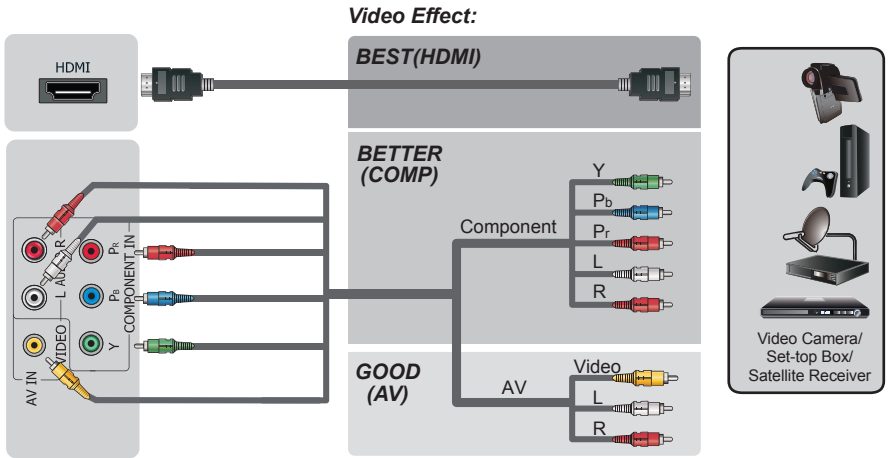

- ▶ **ARC** Connect an HDMI cable from an external digital audio system. ARC enables the TV to directly output the digital sound through an HDMI cable. Please note that it works only when the TV is connected to the audio receiver that supports the ARC (Audio Return Channel) function. When this port is used as the ARC function, it can't be used as signal input at the same time.

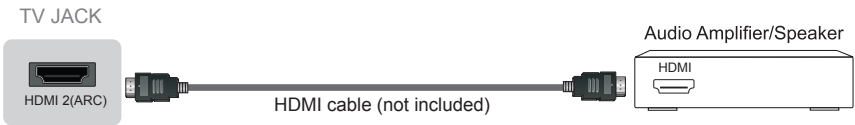

- ▶ **MHL** Connect an MHL cable (not provided) from your MHL-enabled device, such as a cell phone.

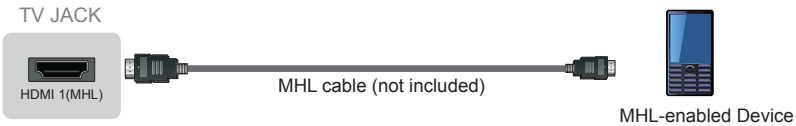

NOTES

- MHL is only available through HDMI 1(MHL) and only when the TV is connected to compatible MHL devices. Please note that not all MHL devices are supported.

Making Connections

- ▶ **HEADPHONE** Connect Headphone for audio out of the TV.

The built-in speakers will be disabled once the headphone is connected.



NOTES

- Please make sure that the headphone you plug in is without microphone function, or it may not be supported.

- ▶ **OPTICAL** Connect an optical cable from an external digital audio system

Optical SPDIF—is a type of digital audio interconnect cable used in consumer audio equipment to output audio over reasonably short distances. The signal is transmitted over a fibre optical cable.

Before connecting a digital audio system to the Optical jack, you should decrease the volume of both the TV and the system to avoid that the volume suddenly become bigger.

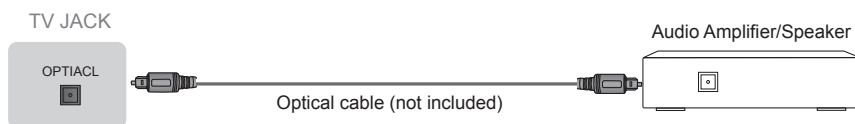

- ▶ **USB**

Connect the USB1.1, USB2.0 devices such as hard drives, USB sticks and digital cameras for browsing photos, listening music and watching recorded movies. You can record live TV program (refer to PVR in user Manual). At the same time update is also an easy thing and will be done just by plugging the USB with the updating files into the USB interface.

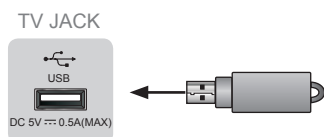

NOTES

- When connecting a hard disk or a USB hub, always connect the mains adapter of the connected device to the power supply.

Making Connections

- If a USB 1.1 or USB2.0 device requires more than 500mA or 5V, the USB device may not be supported. Exceeding the max supported current may result in damage or data loss.
- If you want to store the video streaming of a DTV program, the transfer rate of the USB storage device must not be less than 5MB/s.

▶ LAN (Wired setup)

Connect your TV to your network by connecting the LAN port on the back of your TV to an external modem or router using a LAN (Ethernet/Cat 5) cable. See the illustration below.

- We recommend to use a modem or router that supports Dynamic Host Configuration Protocol (DHCP). Modems and routers that support DHCP automatically provide the IP address, subnet mask, gateway, and DNS, so you don't have to enter them manually. Most home networks already have DHCP.

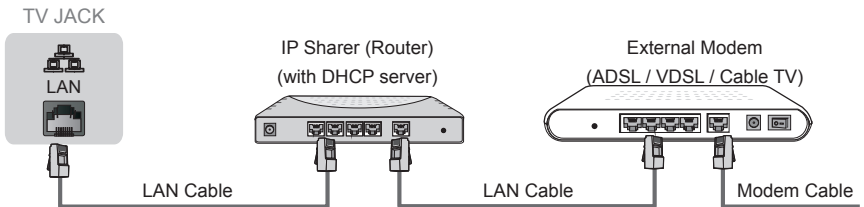

Wireless setup

Connect your TV to your network wirelessly, you need a wireless router or modem. See the illustration below.

- The TV's built-in Wireless LAN Adapter supports the IEEE 802.11 b/g/n communication protocols.



NOTES

- You must use the built-in Wireless LAN Adapter to use a wireless network because the set doesn't support external USB network adapter.
- If the wireless router supports DHCP, your TV can connect more easily to the wireless network.
- If you apply a security system other than the systems listed below, it will not work with the TV.
security system : WPA, WEP, WPA2.
- In order to guarantee smooth network, the distance between router and TV is less than 10 meters.



What is FreeviewPlus?

FreeviewPlus is a new television service delivered via broadband providing a state of the art Electronic Program Guide (EPG) and seamless access to catch-up TV across the free-to-air networks with the simple press of a button.

How does it work?

First ensure the TV is connected to internet and an antenna system. Then when you're watching TV, you'll briefly see a prompt at the top left of the screen. Press the 'Green' button on your remote to launch FreeviewPlus. More information about FreeviewPlus can be found on <http://www.freeview.com.au/>

NOTE

- FreeviewPlus service only available in Australia territories.

Remote Control

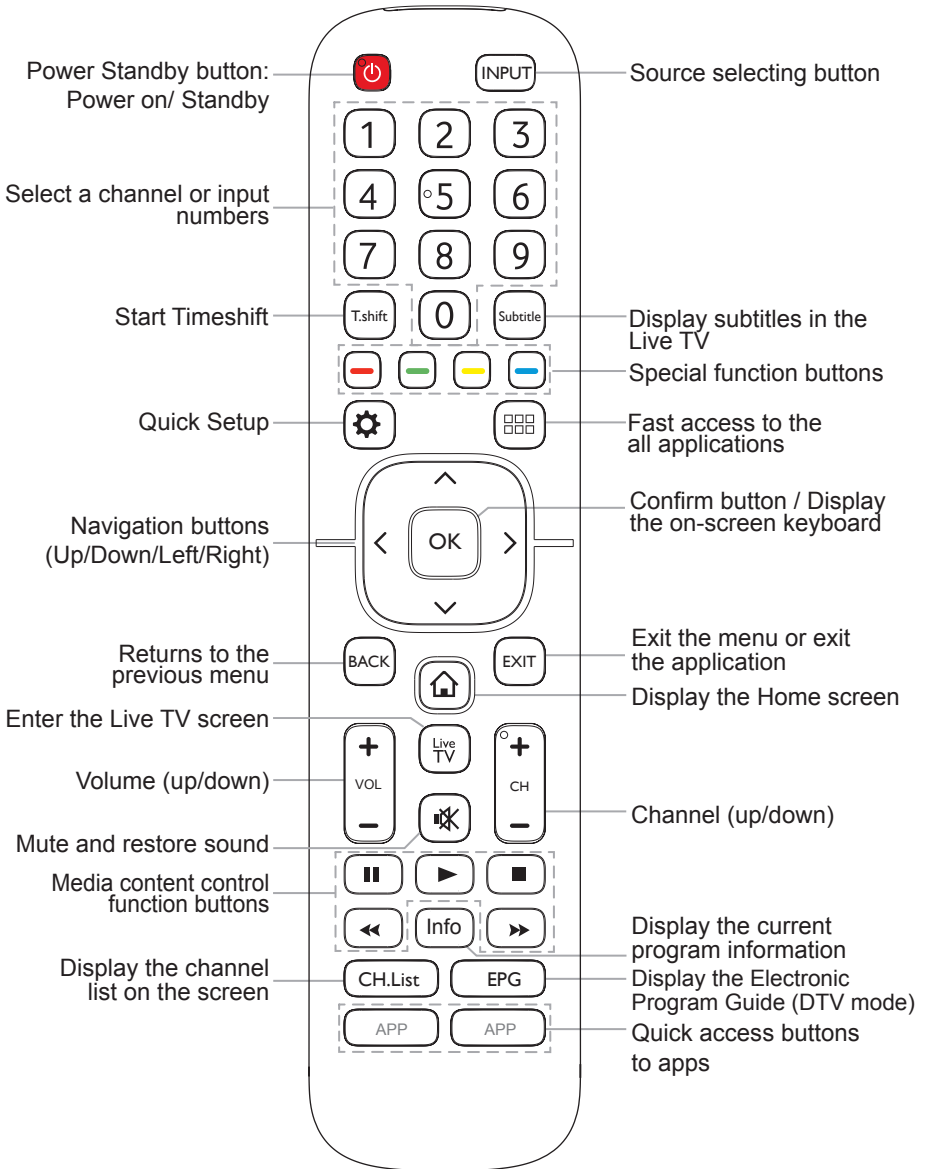

Remote Control

► Installing Batteries in the Remote Control

1. Slide the back cover to open the battery compartment of the remote control.
2. Insert two AAA size batteries. Make sure to match the (+) and (-) ends of the batteries with the (+) and (-) ends indicated in the battery compartment.
3. Close the battery compartment cover.

❶ Gently push and slide

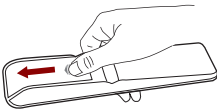

❷ Insert the batteries

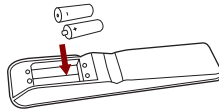

❸ Gently push and slide

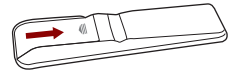

▣ NOTES

- Product image is only for reference, actual product may vary in appearance.
- Dispose of your batteries in a designated disposal area. Do not throw the batteries into a fire.
- Do not mix battery types or combine used batteries with new ones.
- Remove depleted batteries immediately to prevent battery acid from leaking into the battery compartment.
- If you do not intend to use the remote control for a long time, remove the batteries.
- Batteries should not be exposed to excessive heat, such as sunshine, heat registers, or fire.
- Battery chemicals can cause a rash. If the batteries leak, clean the battery compartment with a cloth. If chemicals touch your skin, wash immediately.

► Remote Control Operation Range

1. Point the remote control at the TV within no more than 5 metres from the remote control sensor on the TV and within 60° in front of the TV.
2. The operating distance may vary depending on the brightness of the room.

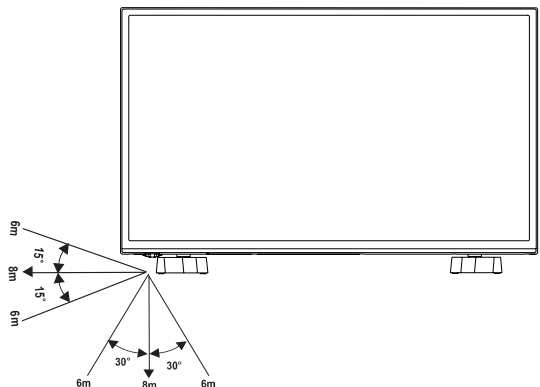

Turning the TV on for the First Time

Turning the TV on for the First Time

1. Connect the mains cable to the mains socket after you have completed all the connections.
2. The first time you turn the TV on, it will go straight into the Installation Guide. It will assist you to specify the Language, Location, Time Zone, Mode, EULA, Network and Input.
3. Press the [\wedge / \vee / \lt / \gt] to navigate the menu and change the settings. Press the [OK] button to confirm.

Language	Select your desired language to be displayed on the menu.
Location	Select the location where you will operate the TV.
Time Zone	Select your location time zone. Next, navigate to the Forward arrow and press [OK] button.
Mode	Select Home Mode and then navigate to the Forward arrow to press [OK] button. NOTE: 'Store mode' should only be selected by Retailers who plan to demonstrate the TV.
EULA	Accept EULA Help promote the TV user experience.
Network	If your TV does not detect an Ethernet connection, then it will select Wireless automatically, select your network from the list that displays and move to the next screen.
Input	Select how you receive your TV channels. Choose from one of the following sources below and then move to the next screen. <ul style="list-style-type: none">• TV• AV• COMPONENT• HDMI NOTE: If you use an antenna to receive channels, then you must complete the first-time setup menu in order to run a channel scan.
Complete	Successful Press [OK] button if you are fine with the selections. Otherwise, navigate to the back arrow on the screen to change your selection.

Specifications

☑ Features, appearance and specifications are subject to change without notice.

If you encountered difficulty when setting up your TV, we suggest you refer to the troubleshooting tips in the User Manual.

Model Name		49K3110PW	50K3110PW	55K3110PW
Dimension	Without Stand(mm)	Width: 1099 Height: 639 Depth: 85	Width: 1120 Height: 651 Depth: 85	Width: 1235 Height: 717 Depth: 84
	With Stand (mm)	Width: 1099 Height: 673 Depth: 218	Width: 1120 Height: 686 Depth: 241	Width: 1235 Height: 752 Depth: 241
Weight	Without Stand(kg)	11.9	12.5	15
	With Stand (kg)	12.1	12.8	15.3
Active Screen Size(Diagonal)		49 inches	50 inches	55 inches
Screen resolution		1920×1080	1920×1080	1920×1080
Audio power		8W +8W	10W +10W	10W +10W
Power consumption		Please refer to the rating label.		
Power supply		100V - 240V~ 50Hz/60Hz		
Receiving systems	Analog	PAL-D/K, B/G, I SECAM-D/K, B/G, L/L'		
	Digital	DVB-T/T2, DVB-C		
Environmental conditions		Temperature: 5°C - 45°C Humidity: 20% - 80% RH Atmospheric pressure: 86 kPa - 106 kPa		
Component Input		480 I / 60 Hz, 480 P / 60 Hz, 576 I / 50 Hz, 576 P / 50 Hz, 720 P / 50 Hz, 720 P / 60 Hz, 1080 I / 50 Hz, 1080 I / 60 Hz, 1080 P / 50 Hz, 1080 P / 60 Hz		
HDMI Input		60 Hz (640×480, 800×600, 1024×768) 60 Hz (480 I, 480 P, 720 P, 1080 I, 1080 P) 50 Hz (576 I, 576 P, 720 P, 1080 I, 1080 P)		