

Bar code

## **QUICK SETUP GUIDE**

Before using the TV, please read this guide thoroughly and retain it for future reference. For more detailed instructions, please see the User Manual.

### Declaration

---

Any content and service accessed through this device, while only intended for individual non-commercial use, shall be the property of the applicable third party and subject to protection by regulations and laws on copyright, patent, trademark and other intellectual property rights. No part of such content and service may be modified, duplicated, published, uploaded, distributed, translated, marketed, or used to make and distribute products derived from it without the prior permission of the content owner or service provider.

You acknowledge and agree explicitly that you will solely bear the risk associated with the use of this device, and further you will solely bear any risk related to satisfactory quality, performance and accuracy for any content and service accessed through this device. To the maximum extent permitted by applicable law, this device and any third party's content and service is provided as it is without any guarantee, express or implied.

Manufacturer hereby declare explicitly that Manufacturer shall not be held liable for any guarantee and conditions, express or implied, related to this device and any content and service, including but not limited to warranty on marketability, satisfactory quality, fitness for a particular purpose, accuracy, quiet use and non-violation of any third party's rights; to the maximum extent permitted by applicable law, Manufacturer gives no guarantee on the accuracy, validity, timeliness, legitimacy and completeness of any content or service provided through this device, or the fitness of such device, content or service for your particular requirement, or the protection from interruption and error during operation of such device, content or service; to the maximum extent permitted by applicable law, in any case, including fault or neglect, Manufacturer shall not be held liable for legal actions or indemnity obligation arising from any consequence as a result of or related to any information loaded in this device or use of such device, content or service by you or any third party.

Any content and service provided as it is together with this device shall be the property of the applicable third party, therefore Manufacturer gives no declaration or warranty on modification, suspension, cancellation, termination or abortion thereof, and shall not be held liable for legal actions or indemnity obligation arising thereof.

Manufacturer reserves the rights to restrict the use or access of certain content or service. As the content and service are transmitted through third party's network and transmission facilities, Manufacturer undertakes no customer service thereof or the obligation for such customer service.

## Important Safety Precautions



This symbol alerts user about the presence of a dangerous voltage not isolated inside the product which can be sufficiently powerful to constitute a risk of electrocution.



This symbol alerts user about the presence of important operating instructions and maintenance in the document enclosed in the package.



### ATTENTION

RISK OF SHOCK  
ELECTRIC



Do not open the back cover.

In no case the user is allowed to operate inside the TV set. Only a qualified technician is entitled to operate.



Class II product: This symbol indicates that it does not require a safety connection of protective earthing (ground).



AC voltage: This symbol indicates that the rated voltage marked with the symbol is AC voltage.



Class I product: This symbol indicates that it requires a safety connection of protective earthing (ground).

## Disposal of Used Electrical & Electronic Equipment



Packaging and electrical goods should be recycled appropriately, and not treated as household waste. Please dispose of this equipment at your applicable collection point for the recycling of electrical & electronic equipment waste. By ensuring the correct disposal of this product, you will help prevent potentially hazardous to the environment and to human health, which could otherwise be caused by unsuitable waste handling of this product. The recycling of materials will help conserve natural resources. Please do not therefore dispose of your old electrical and electronic equipment with your household waste. For more detailed information about recycling of this product, please contact your local city office, your household waste disposal service or the shop where you purchased the product.

## Warning

Never place a television set in an unstable location. A television set may fall, causing serious personal injury or death. Many injuries, particularly to children, can be avoided by taking simple precautions such as:

- Using cabinets or stands recommended by the manufacturer of the television set.
- Only using furniture that can safely support the television set.
- Ensuring the television set is not overhanging the edge of the supporting furniture.

## Important Safety Precautions

- Not placing the television set on tall furniture (for example, cupboards or bookcases) without anchoring both the furniture and the television set to a suitable support.
- Not placing the television set on cloth or other materials that may be located between the television set and supporting furniture.
- Educating children about the dangers of climbing on furniture to reach the television set or its controls.

If your existing television set is being retained and relocated, the same considerations as above should be applied.

## Safeguards

---

Please read the following safeguards for your TV and retain for future reference.

Always follow all warnings and instructions marked on the television.

### 1. A note about safety and operating instructions

Read and follow all safety and operating instructions, and retain them safely for future reference.

### 2. Heed Warnings

Adhere to all warnings on the appliance and in the operating instructions.

### 3. Cleaning

Unplug the TV from the wall outlet before cleaning. Do not use liquid, abrasive, or aerosol cleaners. Cleaners can permanently damage the cabinet and screen. Use a lightly dampened cloth for cleaning.

### 4. Wall Bracket

After market brackets may be available to purchase locally. Please refer to the specification page for dimensions.

### 5. Water and Moisture

Avoid dripping or splashing of liquids onto the product. Objects filled with liquids, such as vases, should not be placed on the product.

### 6. Setting

Do not place this TV on an unstable cart, stand or table. Placing the TV on an unstable base can cause the TV to fall, resulting in serious personal injuries as well as damage to the TV. Use only a cart, stand, bracket or table recommended by the manufacturer or salesperson.

### 7. Ventilation

Slots and openings in the cabinet are provided for ventilation, to ensure reliable operation of the TV and to protect it from overheating. Do not cover the ventilation

## Important Safety Precautions

openings in the cabinet and never place the set in a confined space such as built-in cabinet unless proper ventilation is provided. Leave a minimum 10cm gap all around the unit, the rear of the TV should be 6cm away from the wall.

### 8. Power Source

This TV should be operated only from the type of power source indicated on the marking label. If you are not sure of the type of power supplied to your home, consult your appliance dealer or local power company.

### 9. Power-Cord Protection

Power- supply cords should be routed so that they are not likely to be walked on or pinched by items placed upon or against them, paying particular attention to cords at plug, wall outlets, and the point where they exit from the TV. MAIN plug is used as the disconnect device, the disconnect device shall remain readily operable.

### 10. Lightning

For added protection for this TV during a lightning storm, or when it is left unattended and unused for long periods of time, unplug it from the wall outlet and disconnect the antenna or cable system. This will prevent damage to the TV due to lightning or power-line surge.

### 11. Power Lines

An outside antenna system should not be located in the vicinity of overhead power lines or other electric light or power circuits, or where it can fall into such power lines or circuits. Where installing an outside antenna system, extreme care should be taken to keep from touching such power lines or circuits as contact with them might be fatal.

### 12. Overloading

Do not overload wall outlets and extension cords as this can result in a risk of fire or electric shock.

### 13. Object and Liquid Entry

Never push objects of any kind into this TV through openings as they may touch dangerous voltage points or short-out parts that could result in fire or electric shock. Never spill liquid of any kind on or into the TV.

### 14. Outdoor Antenna Grounding

If an outside antenna or cable system is connected to the TV, be sure the antenna or cable system is grounded so as to provide some protection against voltage surges and built-up static charges.

### 15. Servicing

Do not attempt to service this TV yourself as opening or removing covers may expose you to dangerous voltage or other hazards. Refer all servicing to qualified service personnel.

## Important Safety Precautions

### 16. Damage Requiring Service

Unplug the TV from the wall outlet and refer servicing to qualified service personnel under the following conditions:

- (a) When the power - supply cord or plug is damaged.
- (b) If liquid has been spilled, or objects have fallen into the TV.
- (c) If the TV has been exposed to rain or water.
- (d) If the TV does not operate normally by following the operating instructions. Adjust only those controls that are covered by the operating instructions as an improper adjustment of other controls may result in damage and will often require extensive work by a qualified technician to restore the TV to its normal operation.
- (e) If the TV has been dropped or the cabinet has been damaged.
- (f) When the TV exhibits a distinct change in performance - this indicates a need for service.

### 17. Replacement Parts

When replacement parts are required, be sure the service technician has used replacement parts specified by the manufacturer or have the same characteristics as the original part. Unauthorized substitutions may result in fire, electric shock or other hazards.

### 18. Safety Check

Upon completion of any service or repair to the TV, ask the service technician to perform safety checks to determine that the TV is in safe operating condition.

### 19. Heat

The product should be situated away from heat sources such as radiators, heat registers, stoves, or other products (including amplifiers) that produce heat.



Do not mix and use new batteries with old batteries, or batteries with different types. Do not expose batteries to heat such as direct sunlight or fire. Make sure the batteries' positive and negative ends are facing the correct direction.



The device should not be exposed to dripping and spraying and it cannot be placed under objects filled with liquids.



To fully disconnect the TV, remove power plug from wall socket. Be sure to have the wall socket and power plug readily accessible.



Apparatus with CLASS I construction shall be connected to a MAINS socket outlet with a protective earthing connection.

### NOTES

- No naked flame sources, such as lighted candles, should be placed on the apparatus.
- Excessive sound level from earphones and headphones can cause hearing loss.

# Contents

## Contents

Accessories List.....	1
Installing the Stand .....	2
TV Front.....	4
TV Rear .....	5
Making Connections.....	6
Remote Control .....	11
Turning the TV on for the First Time.....	13
Specifications .....	14

## Accessories List

The following accessories are included with TV:



TV

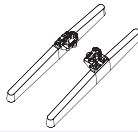

Base Stand



Quick Setup Guide



AAA Batteries × 2



Remote Control



(M5X12)×4



## Installing the Stand

### Installing the Stand

#### ⚠ CAUTION

- Be sure to disconnect the A/C power cord before installing a stand or Wall-Mount brackets.
- The LCD display is very fragile, and must be protected at all times when installing the base stand. Be sure that no hard or sharp object, or anything that could scratch or damage the LCD display, comes into contact with it. DO NOT exert pressure on the front of the TV at any time because the screen could crack.

Follow the illustrations and textual instructions below to complete the installation steps:

1. Carefully place your TV facedown on a soft, flat surface to prevent damage to the TV or scratching to the screen.
2. Remove the 2 stands from the accessory bag and then insert the stands into the bottom slots of the TV.

**Attention:** According to the desktop size, you can select one of the base stand installation, as shown in the figure.

3. Secure the Base Stand to the TV with the 4 screws in accessory tightly.

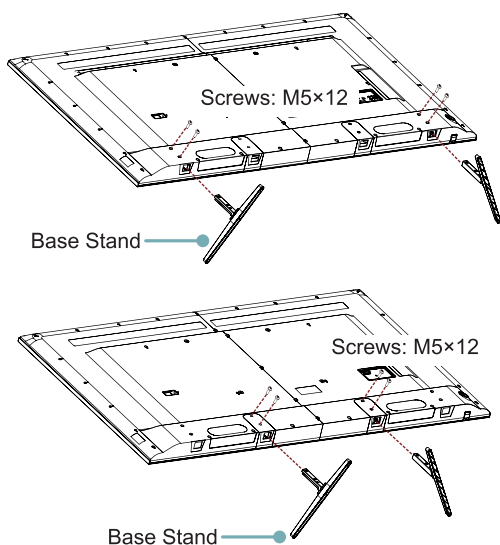

#### NOTE

Product images are only for reference, actual product may vary in appearance.

## Installing the Stand

### ► WALL-MOUNT BRACKET (not provided)

Wall-Mount hole pattern (mm)	400 × 400
Wall-Mount screw size	M6

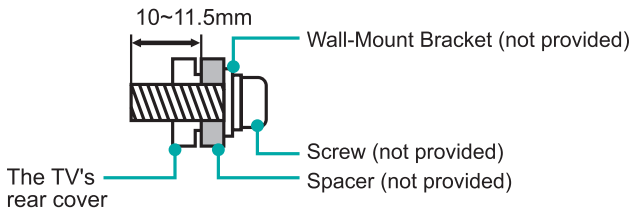

## TV Front

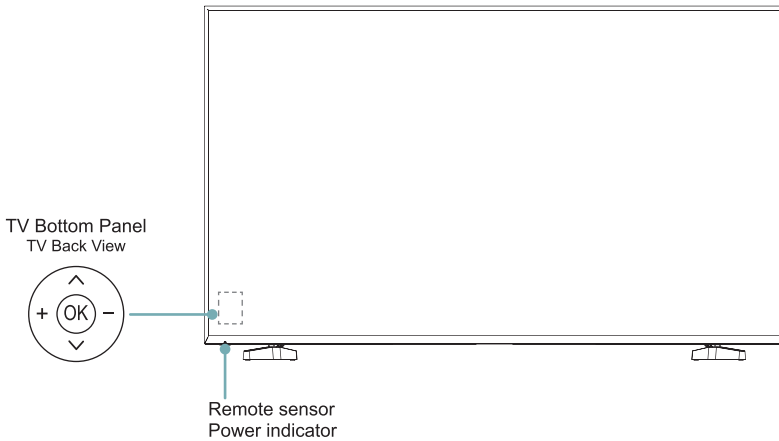

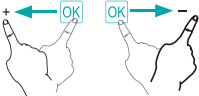
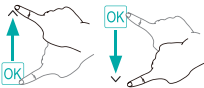
Item	Description
<b>Remote sensor</b>	Receives remote signals from the remote control. Do not put anything near the sensor, as its function may be affected.
<b>Power indicator</b>	The light is red in standby mode.
	Select among the different input signal sources and put the TV in standby mode, and you can turn on the TV when the TV in standby mode.
	Toggle the OK button left and right to adjust the volume.
	Toggle the OK button up and down to select the channel.

### NOTES

- Picture images are only for reference, actual product may vary in appearance.
- It takes several seconds to power on the TV and load program. Do not rapidly turn the TV on and off as it may cause the TV to work abnormally.

## TV Rear

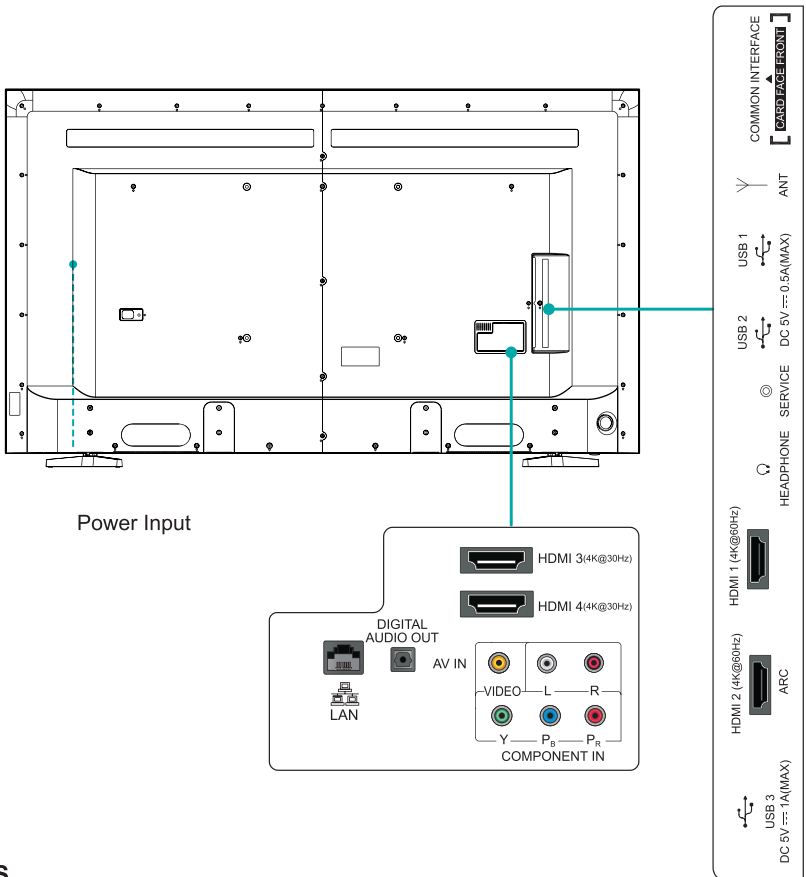

### NOTES

- Pictures are only for reference, actual product may vary in appearance.
- Check the jacks for position and type before making any connections. Loose connections can result in image or sound problems. Make sure that all connections are tight and secure.
- The TV may not be compatible with all external devices. To check compatibility, please refer to the user manual of external device.
- Do not connect external equipment while TV's power cord is plugged in. It may cause electric shock.

## Making Connections

- ▶ **ANT** Connect an outdoor VHF/UHF antenna or cable.

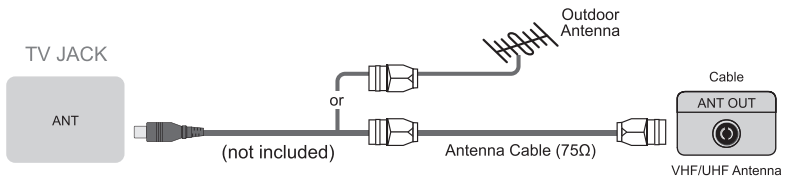

▶ **COMMON INTERFACE**

Insert the CI+ module for watching scrambled services like pay-tv channels or some HD channels.

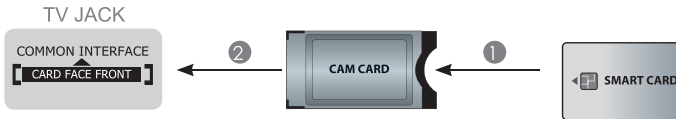

**NOTES**

- Before you insert/remove the CI+ module, ensure that the TV is switched off. Then insert the CI card into the CI+ module in accordance with the Service Provider's instructions.
  - Do not repeatedly insert or remove the Common Access Module as this may damage the interface and cause a malfunction.
  - You must obtain a CI+ module and card from the service provider of the channels you want to watch.
  - Insert the CI+ module with the SmartCard in the direction marked on the module and SmartCard.
  - CI+ is not supported in some countries and regions; check with your authorized dealer.
- ▶ **HDMI/COMP/AV**
- Connect a HDMI / Comp / AV cable from an external A/V equipment. No sound connection is needed for HDMI to HDMI connection. If the signal resolution does not match the specification table, you need to change the setting of device according to the table. Please consult your device user manual for instruction.
- To select the HDMI / Component / AV.  
Press [Input] button, when the list of input Source appears, press [**<** / **>**] to select the source [HDMI] / [COMPONENT] / [AV], then press [OK] to connect.

# Making Connections

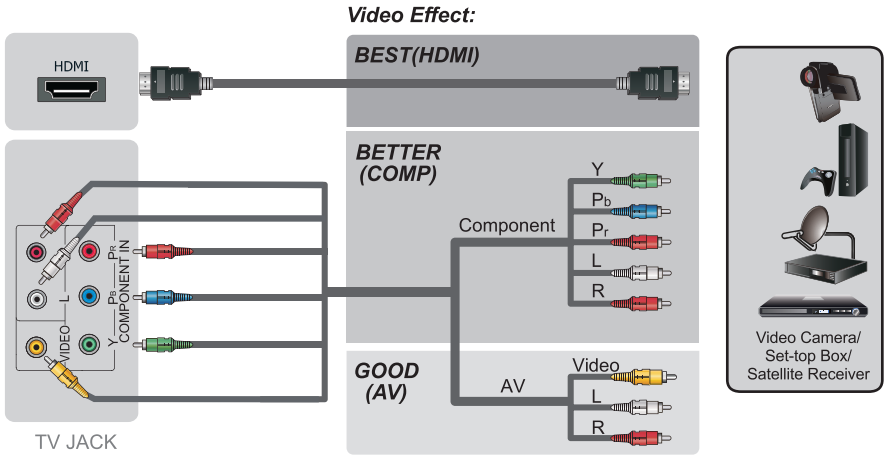

- ▶ **ARC** Connect an HDMI cable from an external digital audio system. ARC enables the TV to directly output the digital sound through an HDMI cable. Please note that it works only when the TV is connected to the audio receiver that supports the ARC (Audio Return Channel) function. When this port is used as the ARC function, it can't be used as signal input at the same time.

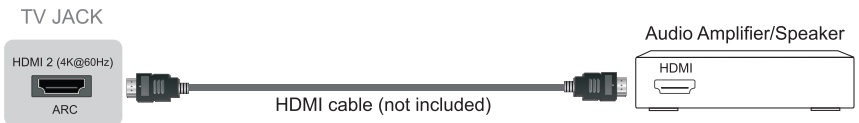

- ▶ **HEADPHONE** Connect Headphone for audio out of the TV. The built-in speakers will be disabled once the headphone is connected.



## Making Connections

### ▶ DIGITAL AUDIO OUT

Connect to an external digital audio system. Before connecting a digital audio system to the DIGITAL AUDIO OUT jack, you should decrease the volume of both the TV and the system to avoid that the volume suddenly becomes bigger.

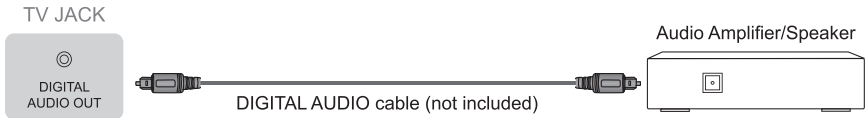

### ▶ USB

Connect the USB1.1, USB2.0 and USB3.0 devices such as hard drives, USB sticks and digital cameras for browsing photos, listening music and watching recorded movies. You can record live TV program (refer to PVR in user Manual). At the same time update is also an easy thing and will be done just by plugging the USB with the updating files into the USB interface.

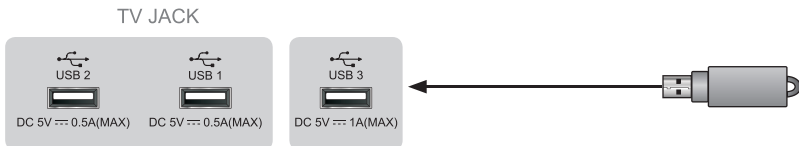

### ☒ NOTES

- When connecting a hard disk or a USB hub, always connect the mains adapter of the connected device to the power supply. If a USB 1.1 or USB2.0 device requires more than 500mA or 5V, the USB device may not be supported. Max supported current for USB 3.0 device is 1A. Exceeding the max supported current may result in damage or data loss.
- If you want to store the video streaming of a DTV program, the transfer rate of the USB storage device must not be less than 5MB/s. Approximately 20GB of storage is required to record 2.5 hours of HD video.

### ▶ LAN (Wired setup)

Connect your TV to your network by connecting the LAN port on the back of your TV to an external modem or router using a LAN (Ethernet/Cat 5) cable. See the illustration below.

- We recommend you to use a modem or router that supports Dynamic Host Configuration Protocol (DHCP). Modems and routers that support DHCP automatically provide the IP address, subnet mask, gateway, and DNS, so you don't have to enter them manually. Most home networks already have DHCP.

## Making Connections

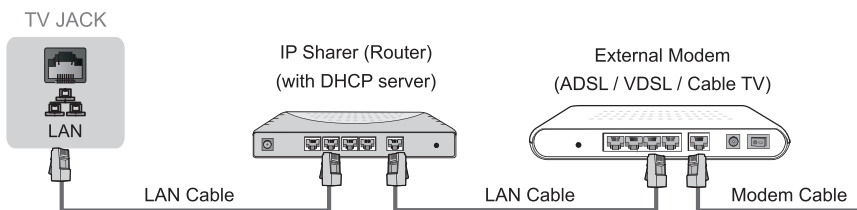

### Wireless setup

Connect your TV to your wireless network, you need a wireless router or modem. See the illustration below.

- The TV's built-in Wireless LAN Adapter supports the IEEE 802.11 b/g/n communication protocols.

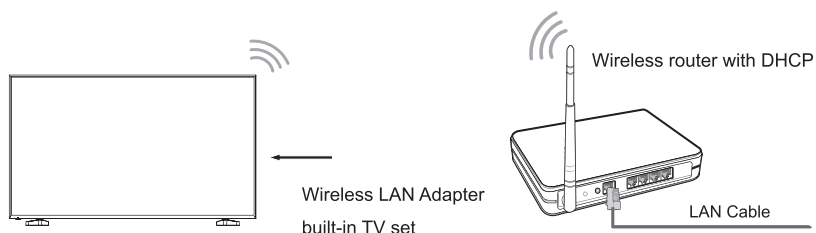

### NOTES

- You must use the built-in Wireless LAN Adapter to use a wireless network because the set doesn't support external USB network adapter.
- If the wireless router supports DHCP, your TV can connect more easily to the wireless network.
- If you apply a security system which is not listed below, it will not work with the TV.  
Security system : WPA, WEP, WPA2.
- In order to guarantee smooth network, the distance between router and TV should be less than 10 meters.



# freeview

### What is FreeviewPlus?

FreeviewPlus is a new television service delivered via broadband providing a state of the art Electronic Program Guide (EPG) and seamless access to catch-up TV across the free-to-air networks with the simple press of a button.

### How does it work?

First ensure the TV is connected to internet and an antenna system. Then when you're watching TV, you'll briefly see a prompt at the top left of the screen. Press the 'Green' button on your remote to launch FreeviewPlus. More information about FreeviewPlus can be found on <http://www.freeview.com.au/>

### NOTE

- FreeviewPlus service only available in Australia territories.

# Remote Control

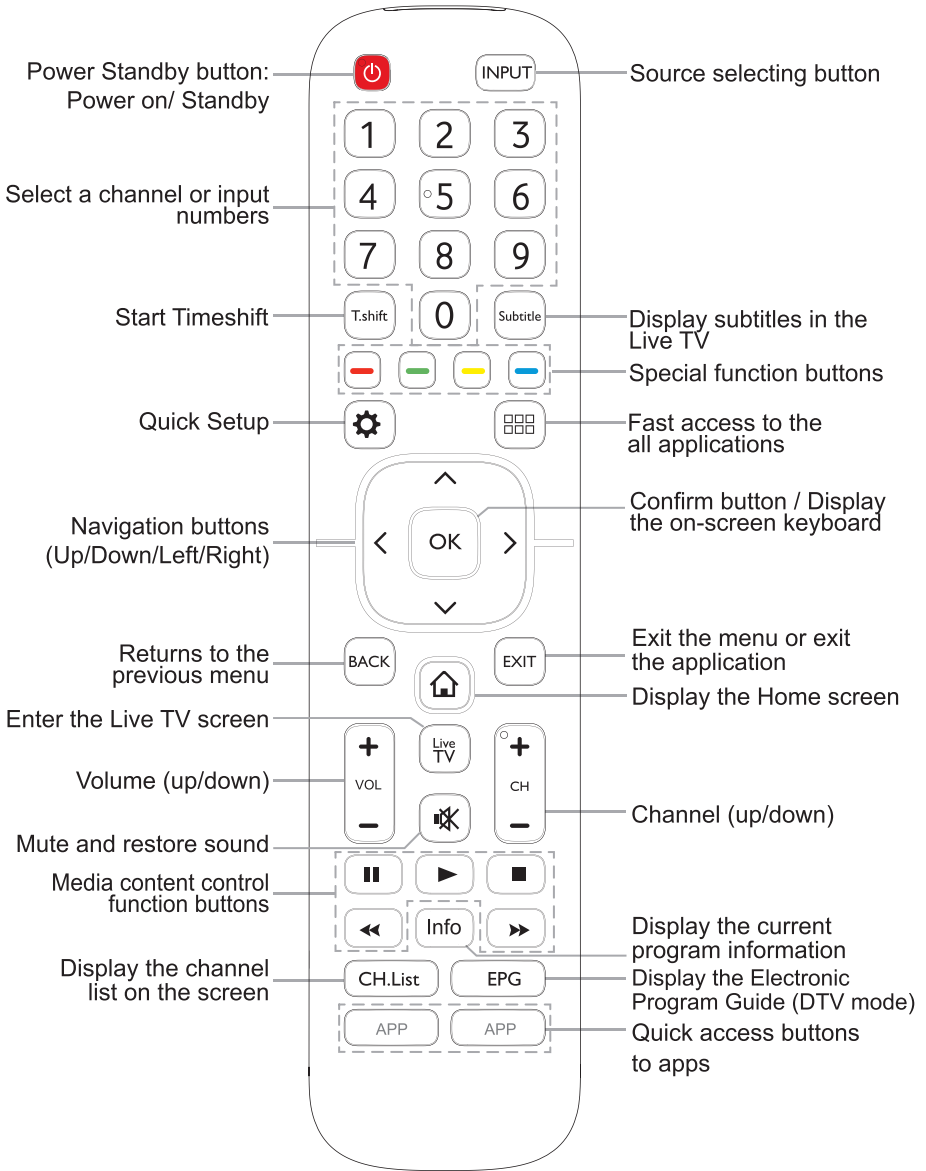

# Remote Control

## ► Installing Batteries in the Remote Control

1. Slide the back cover to open the battery compartment of the remote control.
2. Insert two AAA size batteries. Make sure to match the ( + ) and ( - ) ends of the batteries with the ( + ) and ( - ) ends indicated in the battery compartment.
3. Close the battery compartment cover.

❶ Gently push and slide

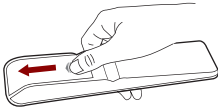

❷ Insert the batteries

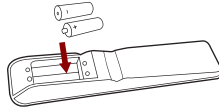

❸ Gently push and slide

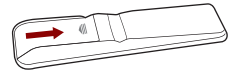

## ▣ NOTES

- Product image is only for reference, actual product may vary in appearance.
- Dispose of your batteries in a designated disposal area. Do not throw the batteries into fire.
- Do not mix battery types or combine used batteries with new ones.
- Remove depleted batteries immediately to prevent battery acid from leaking into the battery compartment.
- If you do not intend to use the remote control for a long time, remove the batteries.
- Batteries should not be exposed to excessive heat, such as sunshine, heat registers, or fire.
- Battery chemicals can cause a rash. If the batteries leak, clean the battery compartment with a cloth. If chemicals touch your skin, wash immediately.

## ► Remote Control Operation Range

1. Point the remote control at the TV within no more than 5 metres from the remote control sensor on the TV and within 60° in front of the TV.
2. The operating distance may vary depending on the brightness of the room.

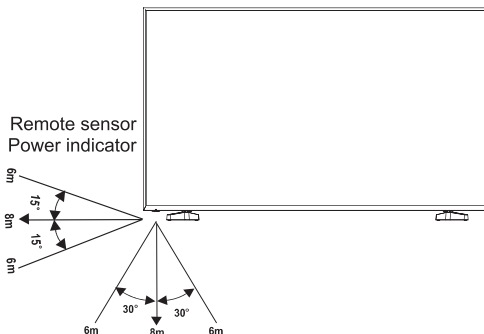

## Turning the TV on for the First Time

### Turning the TV on for the First Time

---

---

1. Connect the mains cable to the mains socket after you have completed all the connections.
2. The first time you turn the TV on, it will go straight into the Installation Guide. It will assist you to specify the Language, Location and Network.
3. Press the [**^** / **v** / **<** / **>**] to navigate the menu and change the settings. Press the [**OK**] button to confirm.

<b>Language</b>	Select your desired language to be displayed on the menu.
<b>Location</b>	Select the location and time zone where you will operate the TV.
<b>Network</b>	Accept EULA and set up network. If your TV does not detect an Ethernet connection, then it will select Wireless automatically, select your network from the list that displays and move to the next screen.
<b>Complete</b>	You have completed the Wizard setup, please select the desired mode.

## Specifications

☑ Features, appearance and specifications are subject to change without notice.

If you encountered difficulty when setting up your TV, we suggest you refer to the troubleshooting tips in the User Manual.

Item		75"
Dimension	Without Stand(mm)	Width: 1678 Height: 963 Depth: 80
	With Stand (mm)	Width: 1678 Height: 1004 Depth: 350
Weight	Without Stand(kg)	35.7
	With Stand (kg)	36.4
Active Screen Size(Diagonal)		75 inches
Screen resolution		3840×2160
Audio power		15W +15W
Power consumption		Please refer to the rating label.
Power supply		100 - 240V~50/60Hz
Receiving systems	Analog	PAL-D/K, B/G, I SECAM-D/K, B/G, L/L'
	Digital	DVB-T/T2, DVB-C
Environmental conditions		Temperature:5°C - 45°C Humidity: 20% - 80% RH Atmospheric pressure: 86 kPa - 106 kPa
Component Input		480 I / 60 Hz, 480 P / 60 Hz, 576 I /50 Hz, 576 P /50 Hz, 720 P / 50 Hz, 720 P / 60 Hz, 1080 I / 50 Hz, 1080 I / 60 Hz, 1080 P / 50 Hz, 1080 P / 60 Hz
HDMI Input		60 Hz ( 640×480, 800×600, 1024×768 ) 60 Hz ( 480 I, 480 P, 720 P, 1080 I, 1080 P ) 50 Hz ( 576 I, 576 P, 720 P, 1080 I, 1080 P ) 24 Hz 30 Hz ( 3840×2160 HDMI 3, 4 ) 24 Hz 30 Hz 50 Hz 60 Hz ( 3840×2160 HDMI 1,2 )