

## **QUICK SETUP GUIDE**

Before using the TV, please read this guide thoroughly and retain it for future reference. For more detailed instructions, please see the User Manual.

# Declaration

## **HISENSE LIMITED PTY WARRANTY AND DISCLAIMER**

### ACCEPTANCE OF TERMS: Televisions

By using this Television, you agree to the terms and conditions outlined in the Warranty and, where applicable, the Disclaimer. If you do not agree to the terms and conditions you have the option to return the Television to the relevant retailer within 7 days of the original purchased date and obtain a refund, provided the Television has not been used or damaged.

## **HISENSE DISCLAIMER**

### THIRD PARTY CONTENT AND SERVICES: Televisions

#### **What does this Disclaimer apply to?**

1. This Disclaimer applies in relation to any television (together with any remote and other accessories supplied with it) (**Television**) supplied by Hisense Australia Pty Ltd (**Hisense**) or an Authorised Retailer, and if you can access any third party software application, content and/or services (**Third Party Content and Services**) through the Television.
2. This Disclaimer does not limit your rights under the Australian Consumer Laws (for Australian customers) or the Consumer Guarantees Act 1993 (for New Zealand customers).

#### **The basis on which Third Party Content and Services are provided**

3. Third Party Content and Services are **accessed and used at your own risk**, regardless of who installed the Third Party Content and Services on the Television. To the maximum extent permitted by law, Hisense makes no warranty, guarantee, representation or undertaking in relation to any Third Party Content and Services.
4. You must comply with any terms and conditions relating to the Third Party Content and Services.
5. Hisense can **restrict your access** or use of certain Third Party Content and Services
6. **Hisense is not liable or responsible for your use of the Third Party Content and Services**, including for any:
  - a. charges relating to your use of the Third Party Content and Services;
  - b. claims, liabilities, loss and damage arising out of (or in connection with) any of the Third Party Content and Services;
  - c. breach of the law or the rights of any other person or entity arising from the use of any Third Party Content and Services; or
  - d. customer service or support in relation to any Third Party Content and Services.
7. **You acknowledge and agree that:**
  - a. the performance of the Third Party Content and Services will depend on variables beyond the control of Hisense;
  - b. certain Third Party Content and Services may require internet access, express consent regarding the collection and use of personal information, other accessories which are sold separately and/or other requirements;
  - c. the Third Party Content and Services (including their intellectual property rights) will remain the property of the relevant provider of the Third Party Content and Services (**Third Party Provider**).
8. **Your other obligations:** You must:
  - a. ensure that your use of the Third Party Content and Services complies with all applicable laws, and the intellectual property and other rights of the Third Party Provider;
  - b. not modify, duplicate, publish, upload, distribute, translate, adapt, market or use any part of the Third Party Content and Services, without the prior written consent of the relevant Third Party Provider unless expressly permitted by this Disclaimer, the Warranty or any other applicable terms and conditions;
  - c. adhere to any additional terms where a Third Party Content or Service requires internet access; and
  - d. pay any additional charges relating to the use of a Third Party Content and Service.

## Important Safety Precautions



This symbol alerts user about the presence of a dangerous voltage not isolated inside the product which can be sufficiently powerful to constitute a risk of electrocution.



This symbol alerts user about the presence of important operating instructions and maintenance in the document enclosed in the package.



**ATTENTION**

**RISK OF SHOCK  
ELECTRIC**



Do not open the back cover.

In no case the user is allowed to operate inside the TV set. Only a qualified technician is entitled to operate.



Class II product: This symbol indicates that it does not require a safety connection of protective earthing (ground).



AC voltage: This symbol indicates that the rated voltage marked with the symbol is AC voltage.

## Disposal of Used Electrical & Electronic Equipment



Packaging and electrical goods should be recycled appropriately, and not treated as household waste. Please dispose of this equipment at your applicable collection point for the recycling of electrical & electronic equipment waste. By ensuring the correct disposal of this product, you will help prevent potentially hazardous to the environment and to human health, which could otherwise be caused by unsuitable waste handling of this product. The recycling of materials will help conserve natural resources. Please do not therefore dispose of your old electrical and electronic equipment with your household waste. For more detailed information about recycling of this product, please contact your local city office, your household waste disposal service or the shop where you purchased the product.

## Important Safety Precautions

### Warning

---

---

Never place a television set in an unstable location. A television set may fall, causing serious personal injury or death. Many injuries, particularly to children, can be avoided by taking simple precautions such as:

- Using stands recommended by the manufacturer of the television set.
- Only using furniture that can safely support the television set.
- Ensuring the television set is not overhanging the edge of the supporting furniture.
- Not placing the television set on tall furniture (for example, cupboards or bookcases) without anchoring both the furniture and the television set to a suitable support.
- Not placing the television set on cloth or other materials that may be located between the television set and supporting furniture.
- Educating children about the dangers of climbing on furniture to reach the television set or its controls.

If your existing television set is being retained and relocated, the same considerations as above should be applied.

# Important Safety Precautions

## Safeguards

---

Please read the following safeguards for your TV and retain for future reference. Always follow all warnings and instructions marked on the television.

### 1. A note about safety and operating instructions

Read and follow all safety and operating instructions, and retain them safely for future reference.

### 2. Heed Warnings

Adhere to all warnings on the appliance and in the operating instructions.

### 3. Cleaning

Unplug the TV from the wall outlet before cleaning. Do not use liquid, abrasive, or aerosol cleaners. Cleaners can permanently damage the cabinet and screen. Use a lightly dampened cloth for cleaning.

### 4. Wall Bracket

After market brackets may be available to purchase locally. Please refer to the specification page for dimensions.

### 5. Water and Moisture

Avoid dripping or splashing of liquids onto the product. Objects filled with liquids, such as vases, should not be placed on the product.

### 6. Setting

Do not place this TV on an unstable cart, stand or table. Placing the TV on an unstable base can cause the TV to fall, resulting in serious personal injuries as well as damage to the TV. Use only a cart, stand, bracket or table recommended by the manufacturer or salesperson.

### 7. Ventilation

Slots and openings in the cabinet are provided for ventilation, to ensure reliable operation of the TV and to protect it from overheating. Do not cover the ventilation openings in the cabinet and never place the set in a confined space such as built-in cabinet unless proper ventilation is provided. Leave a minimum 10cm gap all around the unit, the rear of the TV should be 6cm away from the wall.

### 8. Power Source

This TV should be operated only from the type of power source indicated on the marking label. If you are not sure of the type of power supplied to your home, consult your appliance dealer or local power company.

## Important Safety Precautions

### 9. Power-Cord Protection

Power- supply cords should be routed so that they are not likely to be walked on or pinched by items placed upon or against them, paying particular attention to cords at plug, wall outlets, and the point where they exit from the TV. MAIN plug is used as the disconnect device, the disconnect device shall remain readily operable.

### 10. Lightning

For added protection for this TV during a lightning storm, or when it is left unattended and unused for long periods of time, unplug it from the wall outlet and disconnect the antenna or cable system. This will prevent damage to the TV due to lightning or power-line surge.

### 11. Power Lines

An outside antenna system should not be located in the vicinity of overhead power lines or other electric light or power circuits, or where it can fall into such power lines or circuits. Where installing an outside antenna system, extreme care should be taken to keep from touching such power lines or circuits as contact with them might be fatal.

### 12. Overloading

Do not overload wall outlets and extension cords as this can result in a risk of fire or electric shock.

### 13. Object and Liquid Entry

Never push objects of any kind into this TV through openings as they may touch dangerous voltage points or short-out parts that could result in fire or electric shock. Never spill liquid of any kind on or into the TV.

### 14. Outdoor Antenna Grounding

If an outside antenna or cable system is connected to the TV, be sure the antenna or cable system is grounded so as to provide some protection against voltage surges and built-up static charges.

### 15. Servicing

Do not attempt to service this TV yourself as opening or removing covers may expose you to dangerous voltage or other hazards. Refer all servicing to qualified service personnel.

### 16. Damage Requiring Service

Unplug the TV from the wall outlet and refer servicing to qualified service personnel under the following conditions:

- (a) When the power - supply cord or plug is damaged.
- (b) If liquid has been spilled, or objects have fallen into the TV.
- (c) If the TV has been exposed to rain or water.
- (d) If the TV does not operate normally by following the operating instructions. Adjust

## Important Safety Precautions

only those controls that are covered by the operating instructions as an improper adjustment of other controls may result in damage and will often require extensive work by a qualified technician to restore the TV to its normal operation.

- (e) If the TV has been dropped or the cabinet has been damaged.
- (f) When the TV exhibits a distinct change in performance - this indicates a need for service.

### 17. Replacement Parts

When replacement parts are required, be sure the service technician has used replacement parts specified by the manufacturer or have the same characteristics as the original part. Unauthorized substitutions may result in fire, electric shock or other hazards.

### 18. Safety Check

Upon completion of any service or repair to the TV, ask the service technician to perform safety checks to determine that the TV is in safe operating condition.

### 19. Heat

The product should be situated away from heat sources such as radiators, heat registers, stoves, or other products (including amplifiers) that produce heat.

### 20. Fire

The product should be situated away from naked flame sources such as lighted candle.

### 21. Off-gassing

The TV smells of plastic is normal and will dissipate over time.



Do not mix and use new batteries with old batteries, or batteries with different types. Do not expose batteries to heat such as direct sunlight or fire. Make sure the batteries' positive and negative ends are facing the correct direction.



The device should not be exposed to dripping and spraying and it cannot be placed under objects filled with liquids.



To fully disconnect the TV, remove power plug from wall socket. Be sure to have the wall socket and power plug readily accessible.

# Contents

Figures and illustrations in this manual are provided for reference only and may differ from actual product appearance.

Parts of the software function changes with the system upgrade.

## Contents

Accessories List.....	1
Installing the Stand .....	2
Installing the Wall Mount Bracket .....	3
TV Front.....	4
TV Rear .....	5
Making Connections .....	6
Remote Control .....	11
Turning the TV on for the First Time .....	13
Specifications .....	14

## Accessories List

The following accessories are included with TV:



TV

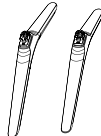

Base Stand



Quick Setup Guide

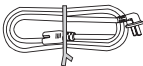

Power cord



AAA Battery × 2



Remote Control

(Actual product may vary in appearance.)



Screw × 4



# Installing the Stand or Wall Mount Bracket

## Installing the Stand

### ⚠ CAUTION

- Be sure to disconnect the A/C power cord before removing a base stand or installing Wall-Mount brackets.
- The screen display is very fragile, and must be protected at all times when installing the base stand. Be sure that no hard or sharp object, or anything that could scratch or damage the screen display, comes into contact with it. DO NOT exert pressure on the front of the TV at any time because the screen could crack.

Follow the illustrations and textual instructions below to complete the installation steps:

1. Carefully place your TV face-down on a soft, flat surface to prevent damage to the TV or scratching to the screen.
2. Take out the 2 stands from the accessory bag and then insert the stands into the bottom slots of the TV.
3. Secure the Base Stand to the TV with the 4 screws in the accessory bag tightly.

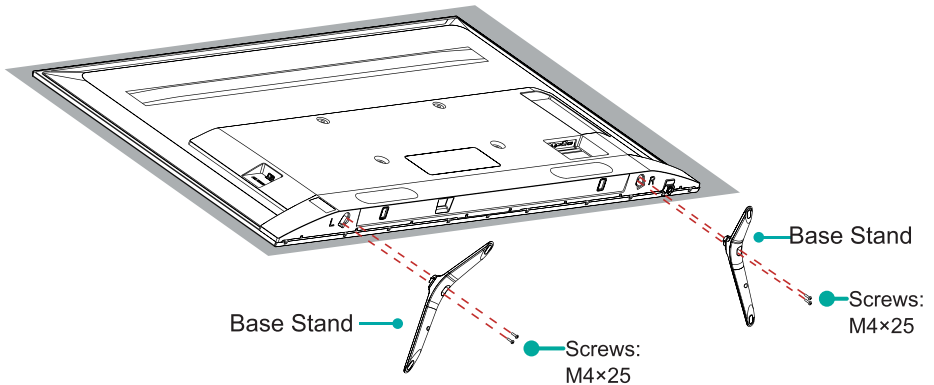

## Installing the Stand or Wall Mount Bracket

### Installing the Wall Mount Bracket

---

---

Wall-Mount hole pattern (mm)	400 × 200
Wall-Mount screw size	M6

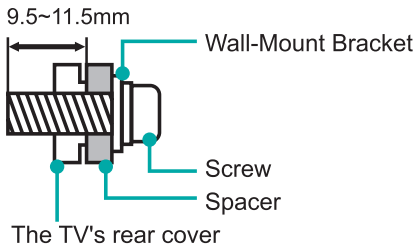

#### NOTES

- Follow instructions provided with the Wall mount bracket.

## TV Front

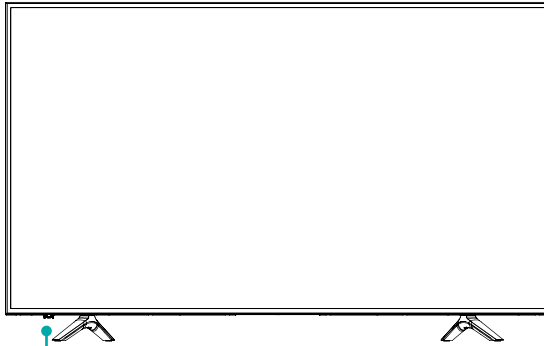

Joystick button (Remote sensor / Power indicator / Standby)

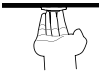
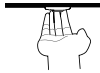
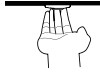
<i>Item</i>	<i>Description</i>
<b>Remote sensor</b>	Receive remote signals from the remote control. Do not put anything near the sensor, as its function may be affected.
<b>Power indicator</b>	The light is red in standby mode.
 <b>Standby / Source</b>	Press the joystick button to power on the TV. Press the joystick button twice to power off the TV. / Press the joystick button to call up the menu and then select among the different input signal sources.
 <b>VOL + / -</b>	Toggle the joystick button right and left to adjust the volume.
 <b>CH + / -</b>	Toggle the joystick button forward and backward to control the channel.

### NOTE

- Powering on the TV requires several seconds to load program. Do not rapidly turn the TV off as it may cause the TV to work abnormally.

# TV Rear

## TV Rear

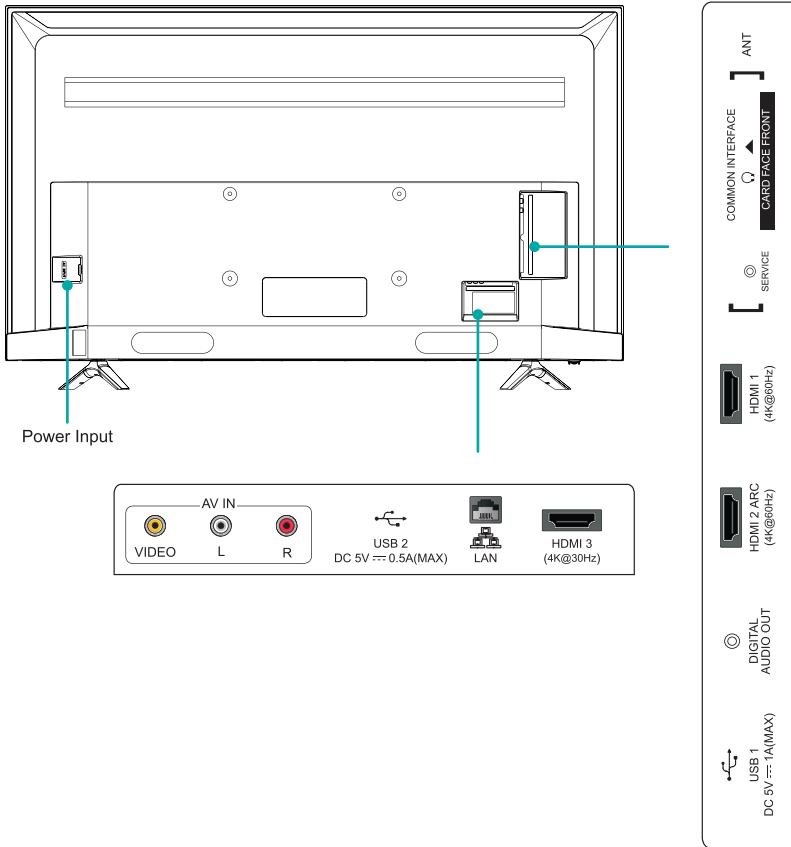

### NOTES

- Check the jacks for position and type before making any connections. Loose connections can result in image or color problems. Make sure that all connections are tight and secure.
- The TV may not be compatible with all external devices. To check compatibility, please refer to the user manual of external device.
- Do not connect external equipment while TV's power cord is plugged in. It may cause electric shock.
- Service jack is not available for you to connect an external device. It can only be used by our factory for testing purposes.

## Making Connections

- ▶ **ANT** Connect an outdoor VHF/UHF antenna or cable.

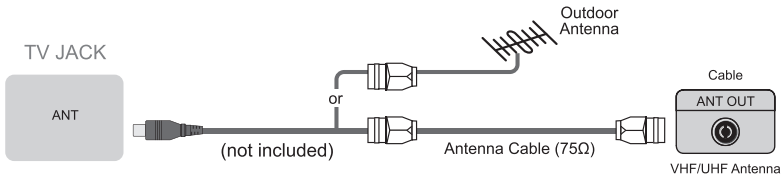

- ▶ **COMMON INTERFACE**

Insert the CI+ module for watching scrambled services like pay-tv channels or some HD channels.

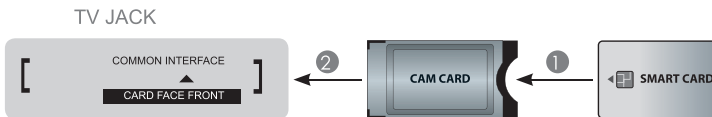

### NOTES

- Before you insert/remove the CI+ module, ensure that the TV is switched off. Then insert the CI card into the CI+ module in accordance with the Service Provider's instructions.
  - Do not repeatedly insert or remove the Common Access Module as this may damage the interface and cause a malfunction.
  - You must obtain a CI+ module and card from the service provider of the channels you want to watch.
  - Insert the CI+ module with the SmartCard in the direction marked on the module and SmartCard.
  - CI+ is not supported in some countries and regions; check with your authorized dealer.
- ▶ **HDMI / AV**

Connect a HDMI / AV cable from an external AV equipment. No sound connection is needed for HDMI to HDMI connection. If the signal resolution does not match the specification table, you need to change the setting of device according to the table. Please consult your device user manual for instruction.

    - To select the HDMI / AV  
Press the **[INPUT]** button, when the list of input Source appears, press the **[^ / v / < / >]** buttons to select the source **[HDMI] / [AV]**, then press the **[OK]** button to connect.

# Making Connections



The terms HDMI and HDMI High-Definition Multimedia Interface, and the HDMI Logo are trademarks or registered trademarks of HDMI Licensing Administrator, Inc. in the United States and other countries.

## Video Effect: **BETTER (HDMI)**

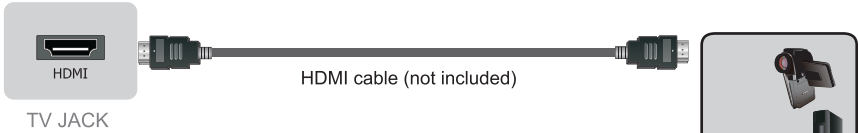

## Video Effect: **GOOD (AV)**

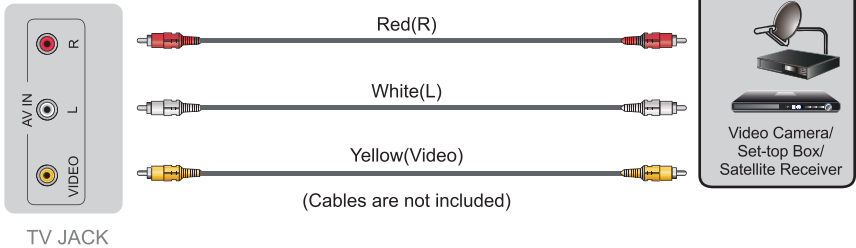

- ▶ **HEADPHONE** Connect Headphone for audio out of the TV. The built-in speakers will be disabled once the headphone is connected.



### ATTENTION

Excessive sound pressure from earphones and headphones can cause hearing loss.

### NOTE

Please make sure that the headphone you plug in is without microphone function, or it may not be supported.

- ▶ **DIGITAL AUDIO OUT** Connect to an external digital audio system. Before connecting a digital audio system to the DIGITAL AUDIO OUT jack, you should decrease the volume of both the TV and the system to avoid that the volume suddenly becomes bigger.

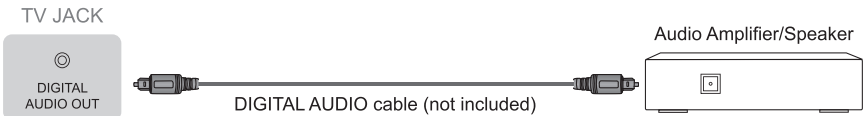

## Making Connections

- ▶ **ARC** Connect an HDMI cable from an external digital audio system.

ARC enables the TV to directly output the digital sound through an HDMI cable. Please note that it works only when the TV is connected to the audio receiver that supports the ARC (Audio Return Channel) function.

When this port is used as the ARC function, it can't be used as signal input at the same time.

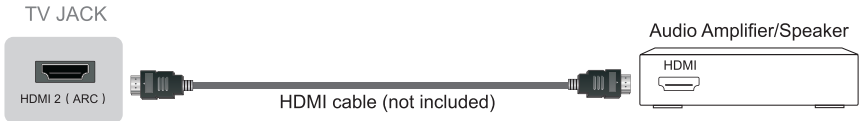

- ▶ **USB**

Connect the USB1.1, USB2.0 and USB3.0 devices such as hard drives, USB sticks and digital cameras for browsing photos, listening music and watching recorded movies.

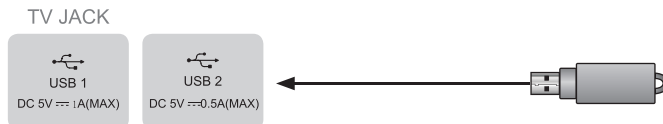

### NOTE

- When connecting a hard disk or a USB hub, always connect the mains adapter of the connected device to the power supply. If a USB 1.1 or USB2.0 device requires more than 500mA or 5V, the USB device may not be supported. Max supported current for USB 3.0 device is 1A. Exceeding the max supported current may result in damage or data loss.

- ▶ **LAN (Wired setup)**

Connect your TV to your network by connecting the LAN port on the back of your TV to an external modem or router using a LAN (Ethernet/Cat 5) cable. See the illustration below.

- We recommend you to use a modem or router that supports Dynamic Host Configuration Protocol (DHCP). Modems and routers that support DHCP automatically provide the IP address, subnet mask, gateway, and DNS, so you don't have to enter them manually. Most home networks already have DHCP.

## Making Connections

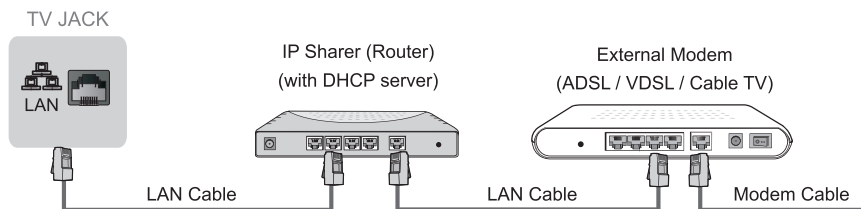

### Wireless setup

Connect your TV to your wireless network, you need a wireless router or modem. See the illustration below.

- The TV's built-in Wireless LAN Adapter supports the IEEE 802.11 ac/a/b/g/n communication protocols.

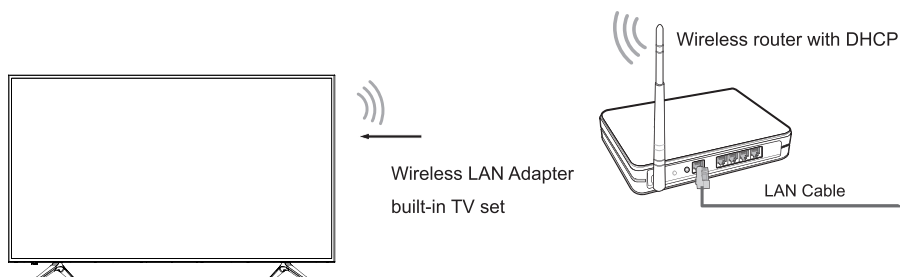

### NOTES

- You must use the built-in Wireless LAN Adapter to use a wireless network because the set doesn't support external USB network adapter.
- If the wireless router supports DHCP, your TV can connect more easily to the wireless network.
- If you apply a security system which is not listed below, it will not work with the TV.  
Security system : WPA, WEP, WPA2.
- In order to guarantee smooth network, the distance between router and TV should be less than 10 meters.



# freeview

### What is Freeview Plus?

Freeview Plus is a new television service delivered via broadband providing a state of the art Electronic Program Guide (EPG) and seamless access to catch-up TV across the free-to-air networks with the simple press of a button.

### How does it work?

First ensure the TV is connected to internet and an antenna system. Then when you're watching TV, you'll briefly see a prompt at the top left of the screen. Press the 'Green' button on your remote to launch Freeview Plus. More information about Freeview Plus can be found on <http://www.freeview.com.au/>

### NOTE

Freeview Plus service only available in Australia territories.

# Remote Control

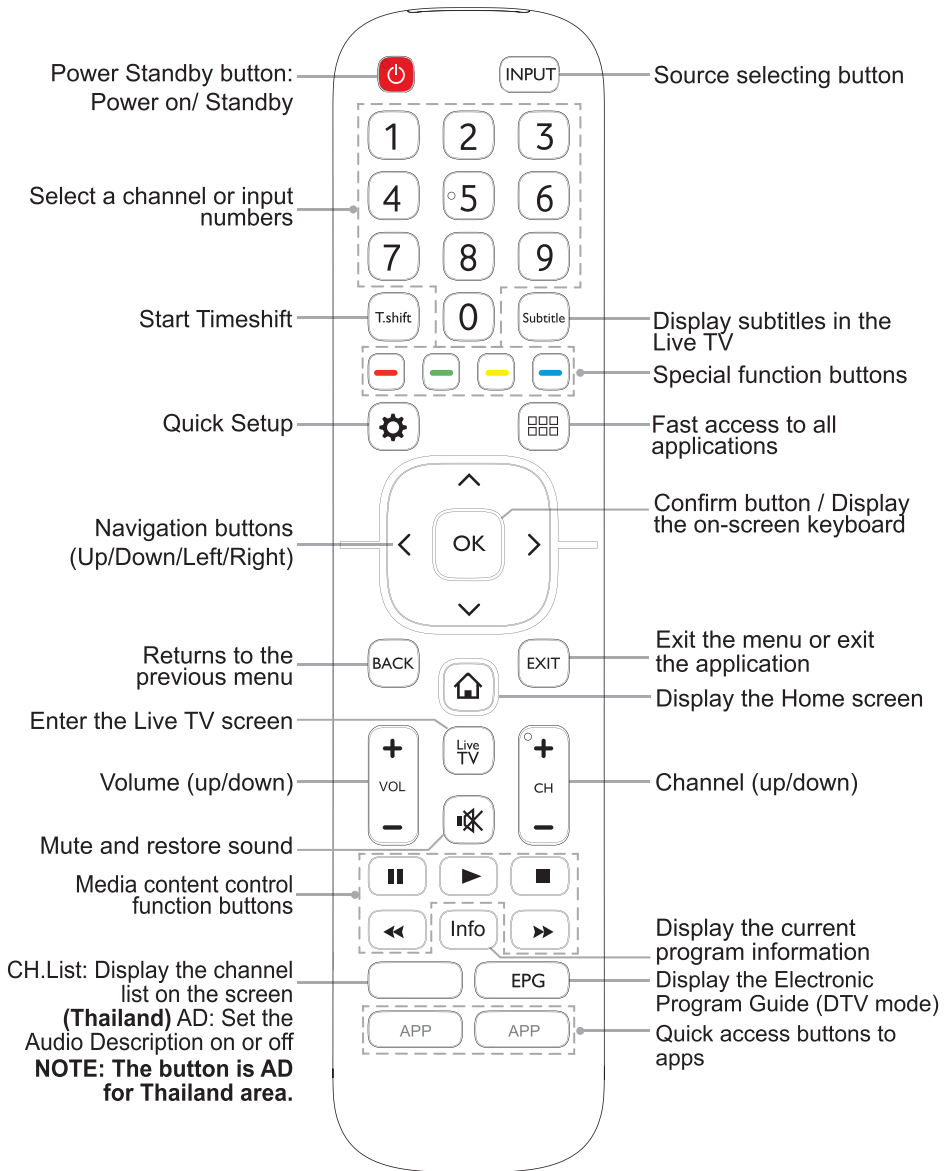

## Remote Control

### ► Installing Batteries in the Remote Control

1. Slide the back cover to open the battery compartment of the remote control.
2. Insert two AAA size batteries. Make sure to match the (+) and (-) ends of the batteries with the (+) and (-) ends indicated in the battery compartment.
3. Close the battery compartment cover.

❶ Gently push and slide

❷ Insert the batteries

❸ Gently push and slide

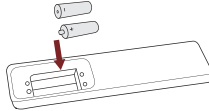
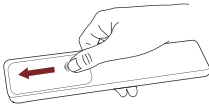

### 📖 NOTES

- Dispose of your batteries in a designated disposal area. Do not throw the batteries into fire.
- Do not mix battery types or combine used batteries with new ones.
- Remove depleted batteries immediately to prevent battery acid from leaking into the battery compartment.
- If you do not intend to use the remote control for a long time, remove the batteries.
- Batteries should not be exposed to excessive heat, such as sunshine, heat registers, or fire.
- Battery chemicals can cause a rash. If the batteries leak, clean the battery compartment with a cloth. If chemicals touch your skin, wash immediately.

### ► Remote Control Operation Range

1. The remote control can work at a distance of up to 8 meters in front of the TV set.
2. The remote control angle: taking the remote sensor as an apex, 6 meters away, its controlled horizontal angle is within  $\pm 30^\circ$ , while the vertical angle is within  $\pm 15^\circ$ .
3. The operating distance may vary depending on the brightness of the room.

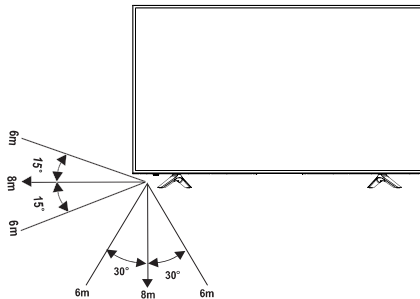

### Disposal of this unit

Product should not be damaged, dismantled or thrown in municipal waste. It should be packed and handed over to authorised re-cycler.

## Turning the TV on for the First Time

### Turning the TV on for the First Time

---

1. Connect the mains cable to the mains socket after you have completed all the connections.
2. The first time you turn the TV on, it will go straight to the Installation Guide.
3. Press the [  $\wedge$  /  $\vee$  /  $\lt$  /  $\gt$  ] to navigate the menu and change the settings. Press the [OK] button to confirm.

<b>Language</b>	Select your desired language to be displayed on the menu.
<b>Location</b>	Select the location where you will operate the TV.
<b>Time Zone</b>	Select the local time zone according to your region. (Only available in certain countries)
<b>End User License Agreement</b>	Accept EULA. Help promote the TV user experience.
<b>Network Connection</b>	If your TV does not detect an Ethernet connection, then it will select Wireless automatically, select your network from the list that displays or you can also add a hidden network. When you're done, move to the next screen.
<b>Success</b>	Congratulations, you have finished the Wizard setup. Press "Finish" to use your TV, for retailers press "Store Mode".

## Specifications

☑ Features, appearance and specifications are subject to change without notice.

If you encountered difficulty when setting up your TV, we suggest you refer to the troubleshooting tips in the User Manual.

Item		65"
Dimension (mm)	Without Stand (W × H × D)	1460 × 847 × 76
	With Stand (W × H × D)	1460 × 908 × 334
Weight (kg)	Without Stand	19.6
	With Stand	20.3
Active Screen Size (Diagonal)		65 inches
Screen resolution		3840 × 2160
Audio power		15W + 15W
Power consumption		Please refer to the rating label.
Power supply		100V - 240V ~ 50Hz/60Hz
Standby Power		0.5W
Receiving systems	Analog	PAL-D/K, B/G, I SECAM-D/K, B/G, L/L'
	Digital	DVB-T/T2, DVB-C
Environmental conditions		Temperature: 5°C - 45°C Humidity: 20% - 80% RH Atmospheric pressure: 86 kPa - 106 kPa
HDMI Input		60 Hz (640×480, 800×600, 1024×768) 60 Hz (480 I, 480 P, 720 P, 1080 I, 1080 P) 50 Hz (576 I, 576 P, 720 P, 1080 I, 1080 P) 24 Hz 30 Hz (3840×2160 HDMI 3) 24 Hz 30 Hz 50 Hz 60 Hz (3840×2160 HDMI 1,2)